



# Reaction to fire test report

Test standard: Ad-hoc test based off ISO 13785-1:2002

Test sponsor: Owners Corporation Plan Number [REDACTED]

System: Aluminium composite panel wall system representative of the in-situ wall located at [REDACTED]  
[REDACTED] - Scenario 1 - Test 2

Job number: RTF220102

Test date: 21 March 2023 Revision: RR2.0

## Quality management

Revision	Date	Information about the report			
RR2.0	29 November 2024	Description	Initial issue		
		Name Signature	Prepared by	Reviewed by	Authorised by
			██████████	██████████	██████████

Warringtonfire\* Australia Pty Ltd  
 ABN 81 050 241 524

\*As used herein, The name "Warringtonfire" and its associated IP and branding is used by Warringtonfire Australia Pty Limited in Australia under licence from Warringtonfire Testing and Certification Limited (based in the UK) for a transitional period following the acquisition of Warringtonfire Australia Pty Limited. The Warringtonfire Testing and Certification Limited continues to own the rights to "Warringtonfire" and continues to operate the global "Warringtonfire business" outside of Australia.

## Contents

1.	Introduction .....	4
2.	Test specimen.....	4
2.1	Schedule of components .....	4
3.	Test procedure.....	9
4.	Test measurements and results .....	10
5.	Application of test results .....	18
5.1	Test limitations .....	18
5.2	Variations from the tested specimen .....	18
5.3	Uncertainty of measurements .....	18
Appendix A	Drawings of test assembly .....	19
Appendix B	Photographs.....	27
Appendix C	Chemical Analysis Results .....	47

## 1. Introduction

This report documents the findings of three ad-hoc reaction to fire tests for an Aluminium composite panel (ACP) and glazing external wall cladding system performed on 21 March 2023. The test was based off some general requirements of ISO 13785-1:2002.

Warringtonfire performed the test at the request of the test sponsor listed in Table 1.

**Table 1 Test sponsor details**

Test sponsor	Address
[REDACTED]	[REDACTED]

## 2. Test specimen

### 2.1 Schedule of components



Table 2 describes the test specimen and lists the schedule of components. These were provided by the representatives of the test sponsor and surveyed by Warringtonfire. All measurements were done by Warringtonfire – unless indicated otherwise.

Detailed drawings of the test specimen are provided in Appendix A.

**Table 2 Schedule of components**

Item	Description	
<b>Cladding</b>		
1.	Item name	ACP Panelling - cassetted
	Product	[REDACTED]
	Manufacturer/Supplier	[REDACTED]
	Material	<p>The panels – which were commercially sourced - consisted of two layers of aluminium sheets sandwiching a layer of polyethylene (PE) with fire-retardant core. The core was grey in colour. These were selected to replicate the panels found onsite at [REDACTED]</p> <p>Chemical analysis was conducted on both the site samples and the commercially available samples and the results were:</p> <p>[REDACTED] report number 22155 conducted by the analytical centre of UNSW showed that the core consisted of 73.4 % aluminium trihydrate, 0.6 % inert filler and 26 % PE.</p> <p>Site sample 1: report number 202212 sample #1 conducted by the analytical centre of UNSW showed that the core consisted of 69.8 % aluminium trihydrate, 1.6 % inert filler and 29 % PE.</p> <p>Site sample 2: report number 202212 sample #2 conducted by the analytical centre of UNSW showed that the core consisted of 69.5 % aluminium trihydrate, 1.6 % inert filler and 29 % PE.</p> <p>Refer to Appendix C for more detailed results.</p>
	Size	<p>As shown in Figure 13.</p> <p>Thickness – 4 mm</p> <p>Skin thickness – 0.5 mm</p> <p>Depth – 150 mm (200 mm total cavity depth)</p>
	Batch	[REDACTED]
	Nominated mass densities	Panel areal density – 7.5 kg/m <sup>2</sup>

Item	Description	
2.	Item name	Back-pan
	Product	[REDACTED]
	Supplier	[REDACTED]
	Material	Galvanised steel
	Batch	Unknown
	Size	Measured: 1160 mm wide × 3700 mm tall 0.6 mm thick – in segments.
<b>Glazing</b>		
3.	Item name	Double glazing
	Material	IGU-5 mm 'Bite' / 6 mm CLEAR HEAT STRENGTHENED / 6.76 mm CLEAR LAMINATE
	Size (nominal)	1188 mm wide × 1800 mm tall × 5 mm/6 mm/6.76 mm with a 12 mm black spacer.
	Manufacturer/Supplier	[REDACTED]
	Batch	[REDACTED]
4.	Item name	Single glazing
	Material	6 mm toughened glass
	Size (nominal)	1182 mm wide × 1800 mm tall × 6 mm thick
	Manufacturer/Supplier	[REDACTED]
	Batch	[REDACTED]
<b>Framing</b>		
5.	Item name	Test rig frame - 90 × 90 SHS and 200 × 90 PFC frame
	Size	90 mm × 90 mm × 5 mm thick and 200 mm × 90 mm × 10 mm thick – refer to Figure 12.
6.	Item name	Aluminium curtain wall transom/mullions (rectangular hollow sections) – framing
	Size	65 mm to 70 mm wide × 116 mm deep × 3 mm thick.
	Manufacturer/Supplier	[REDACTED]
7.	Item name	Aluminium angles - framing
	Size	25 mm wide × 50 mm deep × 3 mm thick
	Manufacturer/Supplier	[REDACTED]
8.	Item name	Aluminium angles – for middle double back-pan unit.
	Size	25 mm wide × 50 mm deep × 3 mm thick
	Manufacturer/Supplier	[REDACTED]
	Installation	Used to secure the secondary back-pan in the within the middle module. The angle was screw fixed to both the back-pan (item 2) and the aluminium framing (item 6) using screws (item 18).
9.	Item name	Aluminium stiffener - framing
	Size	3 mm thick × 150 mm deep
	Manufacturer/Supplier	[REDACTED]
10.	Item name	Curtain wall bracket
	Size	150 mm deep (7 mm thick) × 75 tall (10 mm thick) × 100 mm wide
	Installation	Used to secure the 3 modules to the test rig using tek screws.

Item	Description	
<b>Smoke seal</b>		
11.	Item name	Smoke seal
	Size	0.55 mm thick galvanised steel
	Manufacturer/Supplier	██████████
<b>Penetration</b>		
12.	Item name	Exhaust
	Size	Backing plates: 355 mm × 355 mm × 0.6 mm thick Large tube: Ø155 mm × 330 mm long × 0.5 mm thick Small tube: Ø100 mm × 300 mm long × 0.6 mm thick Cap: Ø200 mm × 0.6 mm thick Connecting strips: 45 mm × 5 mm wide × 0.5 mm thick
	Material	Galvanised steel
	Manufacturer/Supplier	████
	Pictures	<div style="display: flex; justify-content: space-around; align-items: center;"> <div style="text-align: center;">  <p>Exposed side</p> </div> <div style="text-align: center;">  <p>Unexposed side</p> </div> </div>
Installation	These penetrating elements were a galvanised steel tube with a smaller galvanised steel tube inside. On the glazing side was a circular cap connected to the large tube via 15-off strips. Between the glazing and the inner back-pan was a square compartment made from galvanised steel which hid the tubing.	
<b>Insulation</b>		
13.	Item name	90 mm thick polyethylene terephthalate (PET) insulation
	Density	10 kg/m <sup>3</sup>
	Manufacturer/Supplier	██████████
14.	Item name	50 mm thick aluminium - with fibre-glass mesh - foil faced rockwool insulation
	Density of core	40 kg/m <sup>3</sup>
	Manufacturer/Supplier	██████████
<b>Sealant/Adhesive</b>		
15.	Item name	Weathering sealant
	Product type	██████████
	Manufacturer/Supplier	██████████
	Usage	Placed at ACP edges and screw and rivet locations.
16.	Item name	Back-pan sealant - Fire-rated mastic
	Product type	██████████
	Manufacturer/Supplier	██████████
	Usage	Used between the back-pans (item 2) and the aluminium framing (item 7).
17.	Item name	Penetration sealant

Item	Description	
	Product type	██████████
	Manufacturer/Supplier	██████████
	Usage	Used between the back-pans (item 2) and the aluminium framing (item 7).
<b>Fixings</b>		
18.	Item name	Tek screws SDS – zinc coated steel – for fixing the back-pan
	Size	10g × 24 mm long
	Installation	Used to fix aluminium angles (item 8) to the aluminium frame (item 6) at max. 500 mm centres
19.	Item name	Wafer head screws – zinc coated steel
	Size	10g × 16 mm long
	Installation	Used to fix aluminium angles (item 8) to the aluminium frame (item 6) at max. 500 mm centres
20.	Item name	Wafer head screws – zinc coated steel
	Size	10g × 20 mm long
	Installation	Used to fix the penetration backing plate (item 12) to the back-pan (item 2) of the central module.
21.	Item name	Wafer head screws – zinc coated steel
	Size	10g × 21 mm long
	Installation	Used to fix ACP (item 1) to the aluminium stiffener (item 9) – four per corner.
22.	Item name	Aluminium rivets
	Size	Ø4 mm
23.	Item name	Fast-fix washers and pin weld (to hold insulation)
	Size	115 mm × 3 mm pins and 25 mm × 25 mm fast fix washers.
24.	Item name	Tek screws for curtain wall bracket
	Size	14 g × 35 mm long
25.	Item name	Tek screws for smoke seal to false slab i.e. C-Purlin
	Size	14 g × 35 mm long
<b>Installation method</b>		
Test rig:	The test rig frame (item 5) was the main support for the test specimen, however, there were two C-purlin sections that acted as false slabs (200 mm tall). The test specimen, 3-off modules – interconnected through aluminium framing (item 6), was fixed to the test rig using curtain wall brackets (item 10) and fixings (item 24) – see Figure 14 & Figure 15. Each module extended from the bottom of the specimen to the top.	
Framing:	The main framing for the external wall was composed of aluminium extrusions (item 6) which were screw fixed together. Aluminium angles (item 8) – horizontal edges - and stiffeners (item 9) – on the vertical edges - were fixed to the aluminium framing (item 6), using wafer head screws (item 20) and aluminium rivets (item 22), respectively.	
Cladding:	<p>The front face of the specimen was cladded with cassetted ACPs (item 1), which were fixed to the aluminium stiffeners (item 9) and the aluminium angles (item 8) using aluminium rivets (item 22), 2-off at 300 mm centres. See Figure 13 for panel locations.</p> <p>The back side of the framing was closed off with steel back-pans (item 2) screw fixed (item 18) at 300 mm centres. PET insulation (item 13) was fixed to the back-pan using fast-fix washers and pin combinations (item 19) that were welded to the back-pan. The centre module had an extra back-pan behind the glazing (item 4). This was fixed to the aluminium framing (item 6) using screws (item 18) and aluminium angles (item 8). Foil-faced rockwool insulation (item 14) was inserted between the two back-pans (item 2) of the centre module.</p>	

Item	Description
Glazing	The glazing, both double (item 3) and single (item 4), were attached to the aluminium framing (item 6) as shown in Figure 13 to Figure 18 and Figure 19. The glazing was sealed around the perimeter with weather sealant (item 15).
Smoke seal	Smoke seal barrier (item 11) was attached to C-purlins of the test rig (item 5) with screw fixings (item 24) at approximate 600 mm centres. PET insulation (item 13) was installed into the 60 mm wide cavity above the barrier (item 12).
Penetration	The penetration went through holes in the single glazing (item 4) and back-pans (item 2) of the second module. These were fixed to the back-pan and the window with a steel sheet (baking plate), using screws and sealant and just sealant, respectively.

### 3. Test procedure

Table 3 details the test procedure for this reaction to fire test.

**Table 3 Test procedure**

Item	Detail
Statement of compliance	The ad-hoc test – which was based off ISO 13785-1:2002 - was performed to determine the reaction to fire performance of an external wall cladding when exposed to heat from a simulated external fire with flames impinging directly upon a façade. The test utilises a burner used in ISO 13785-1:2002 with the specimen mimicking the as-is construction of the façade.
Sampling / specimen selection	<p>The laboratory was not involved in sampling or selecting the test specimen for the reaction to fire test.</p> <p>The results obtained during the test only apply to the test samples as received and tested by Warringtonfire.</p>
Test duration	60 minutes
Instrumentation and equipment	<ul style="list-style-type: none"> <li>• 21 mineral insulated metal sheathed (MIMS) Type K thermocouples with an overall diameter of 1.5 mm with the measuring junction insulated from the sheath were positioned 60 mm in front of the outer ACP face of the test specimen. Refer to Figure 1 for details on positioning.</li> <li>• The incident heat flux on the top of the specimen in line with the front face of test specimen was measured using a Schmidt-Boelter type heat flux gauge with a range of 0-100 kW/m<sup>2</sup>.</li> <li>• The incident heat flux 500 mm behind the outer glazings – burner side and non-burner side – was measured using two Schmidt-Boelter type heat flux gauges with a range of 0-50 kW/m<sup>2</sup> and 0-20 kW/m<sup>2</sup>, respectively.</li> <li>• The incident heat flux 80 mm behind the central glazing was measured using a Schmidt-Boelter type heat flux gauge with a range of 0-20 kW/m<sup>2</sup>.</li> <li>• Temperatures above and below the cladding were measured by seven 100 mm × 100 mm × 0.7 mm plate thermocouples with mineral insulated metal sheathed (MIMS) Type K thermocouples with an overall diameter of 1 mm with the measuring junction electrically insulated from the sheath. The thermocouple hot junction was fixed to the geometric centre of the plate by a small steel strip made from the same material as the plate. The plate thermocouples included 97 mm × 97 mm × 10 mm inorganic insulation pads. Before the first use of the plate thermocouples, they were aged by being exposed to heat in a fire-resistance test furnace for 90 min under the standard temperature/ time curve. Refer to Figure 1 for details on positioning.</li> <li>• The fire source was a propane (95% purity) gas burner 1.2 m long × 0.1 m deep × 0.15 m tall. The burner was placed on the floor below the specimen with approximately 15 mm overlap with the ACP.</li> </ul>
Test procedure	<ul style="list-style-type: none"> <li>• At least two minutes of baseline data was collected prior to burner ignition. Temperature and heat flux data was collected at 5 s intervals.</li> <li>• The heat output from the burner was held at 300 kW for the 30 minutes. The burner was then turned off and data recorded for the next 30 minutes.</li> </ul>
Test number	<ul style="list-style-type: none"> <li>• Test two of three.</li> </ul>

## 4. Test measurements and results

The results from the tests are summarized below. Photographs of the specimen are included in Appendix B.

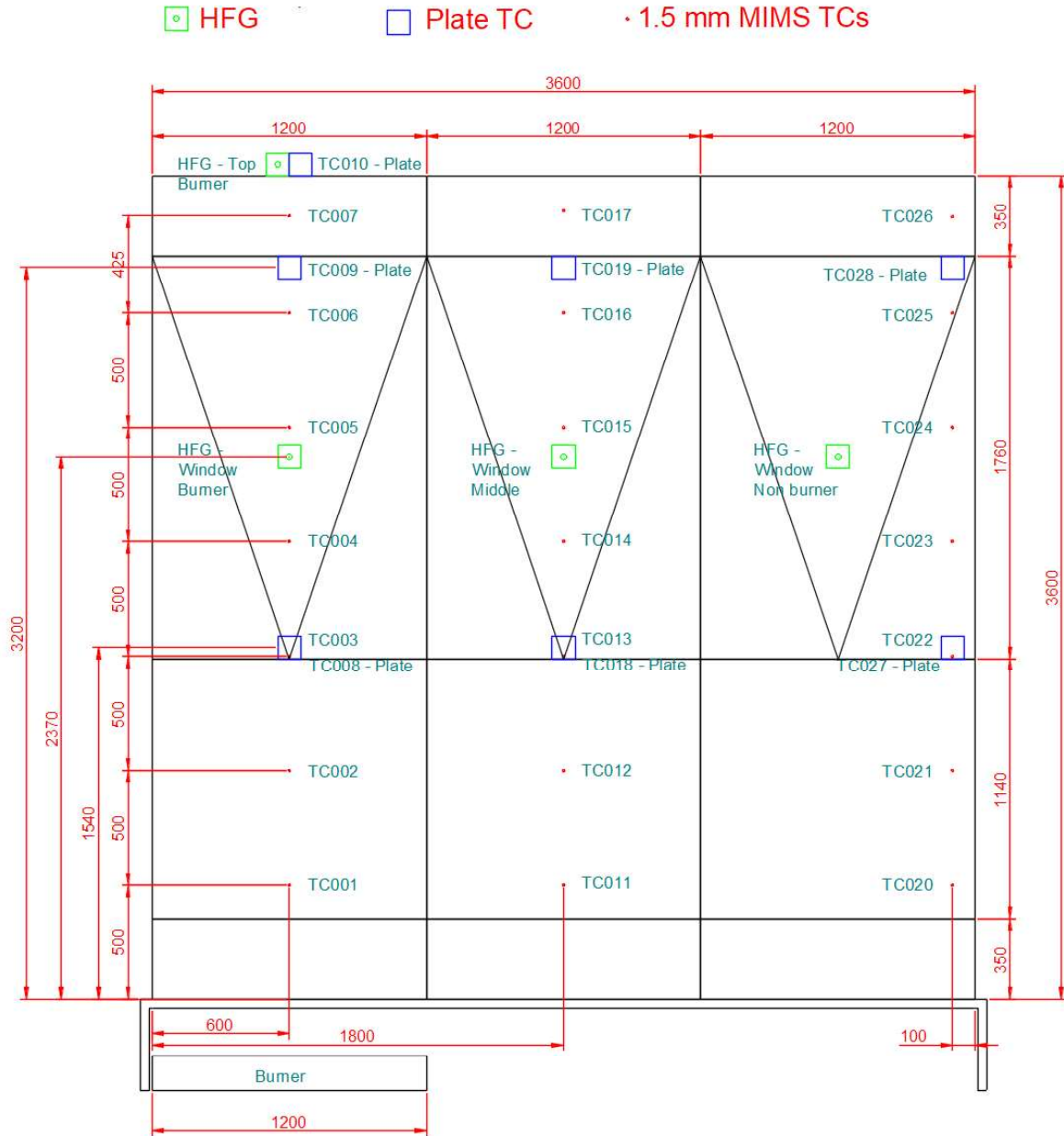

Figure 1 Instrumentation locations – front elevation

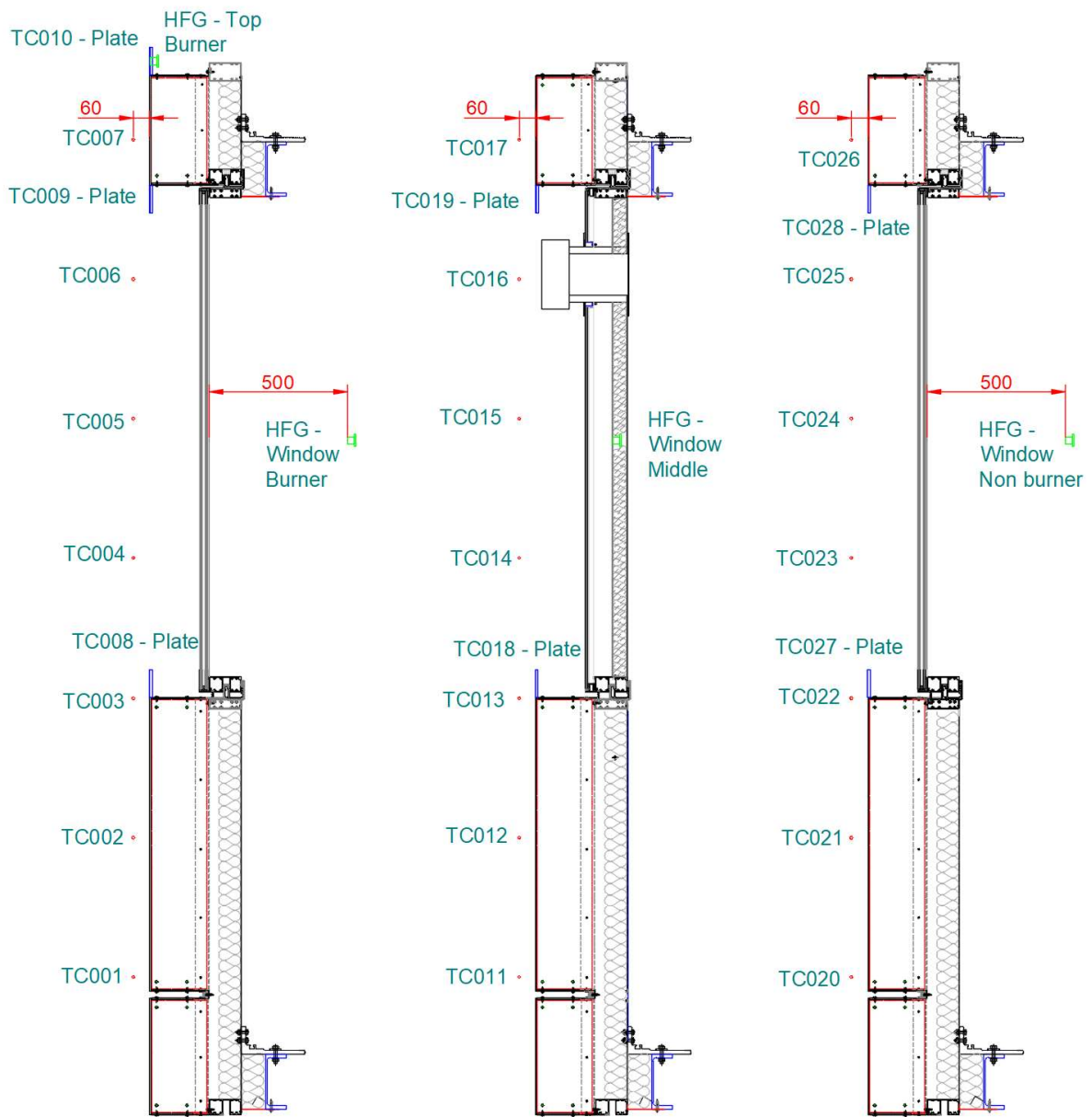
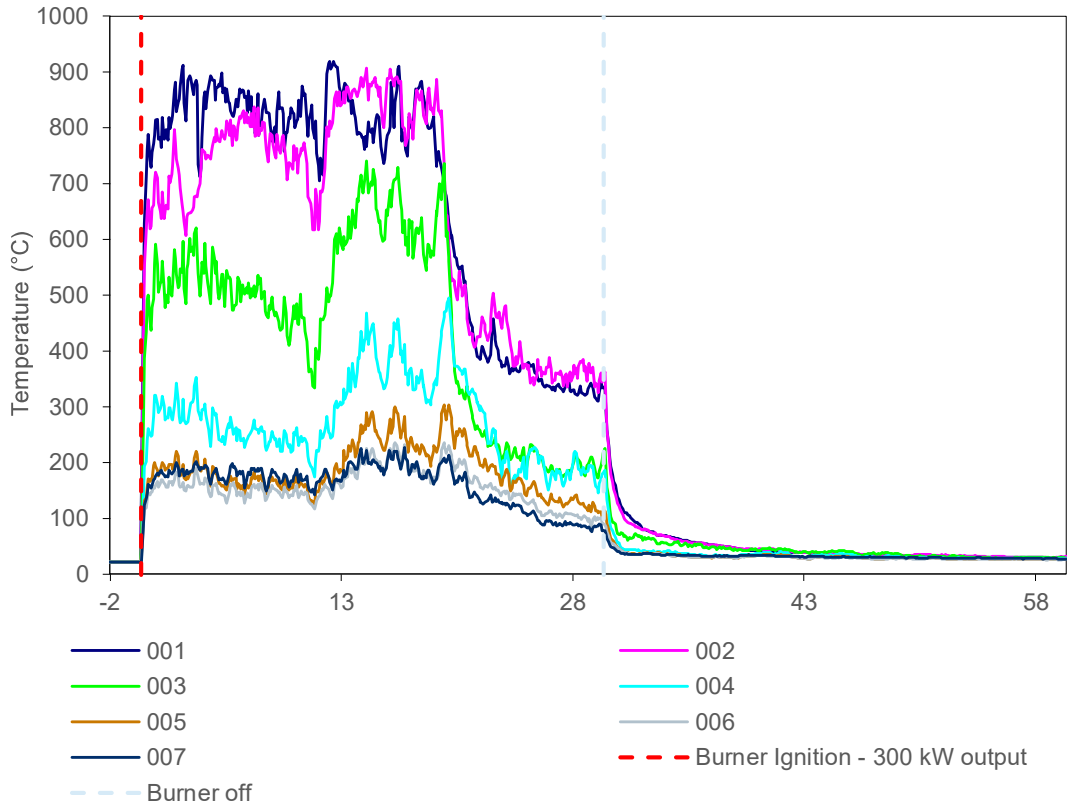
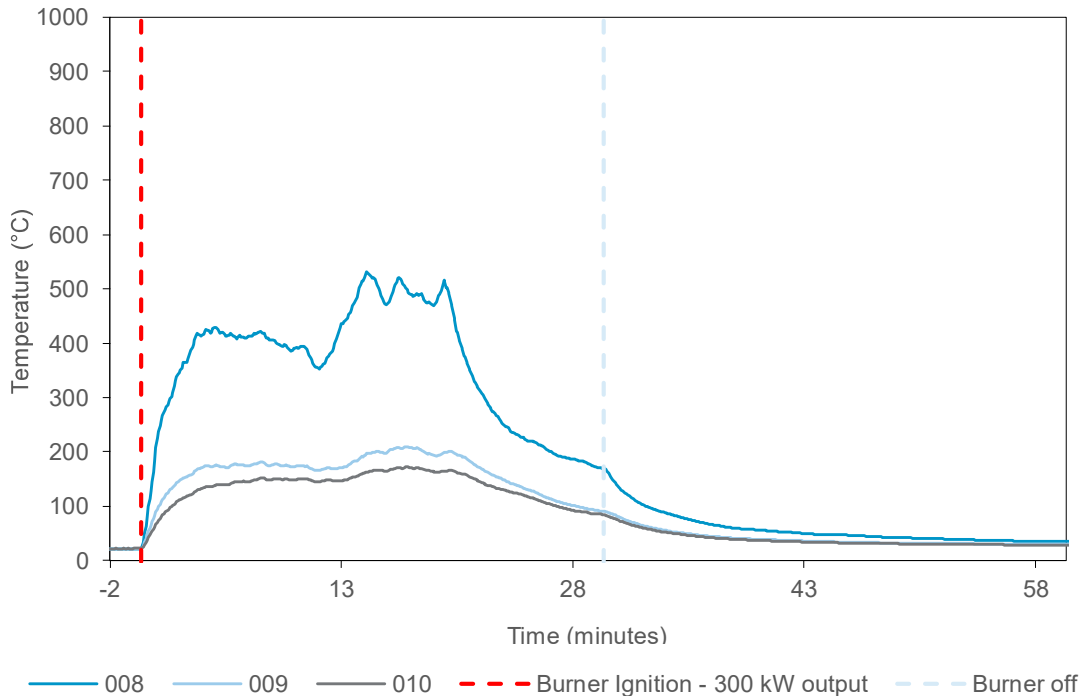

Figure 2 Instrumentation locations – sections



**Figure 3 External temperature data collected by thermocouples placed 60 mm from the front face of the specimen - in-line with the burner.**



**Figure 4 External temperature data collected by thermocouples in-line with ACP, above and below, respectively - in-line with the burner.**

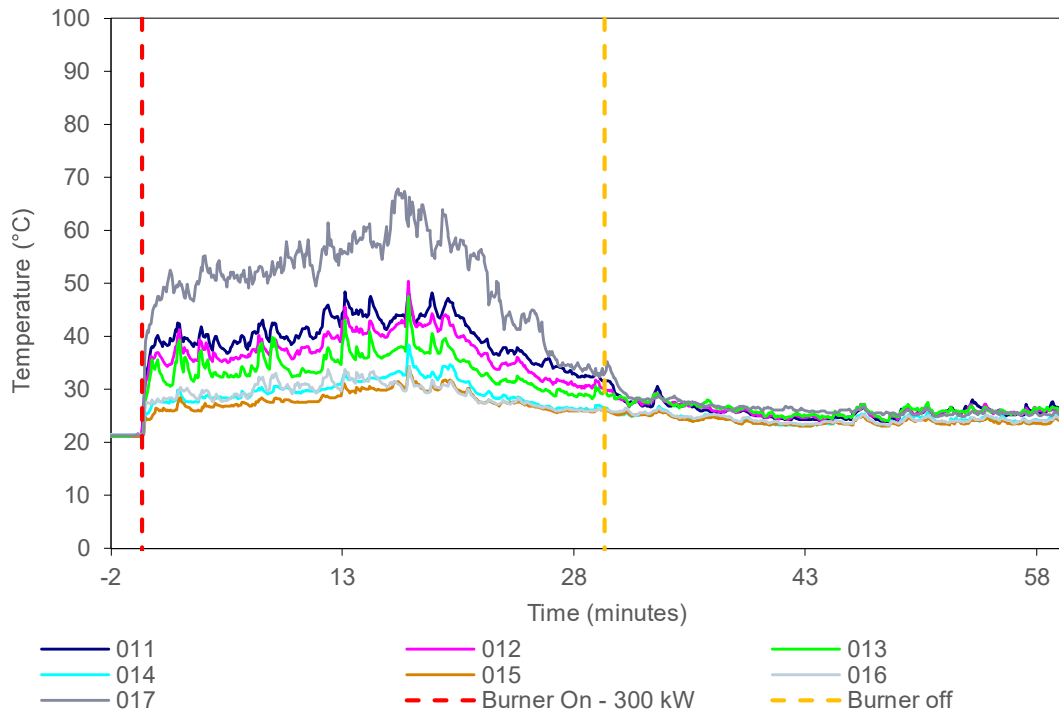

**Figure 5 External temperature data collected by thermocouples placed 60 mm from the front face of the specimen – central module.**

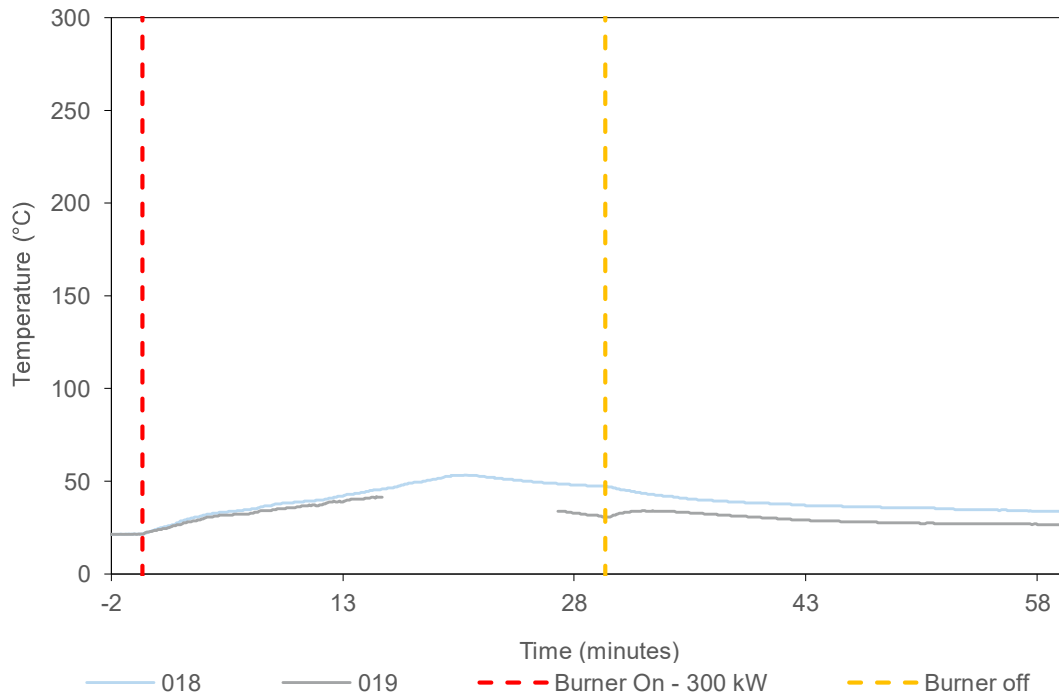

**Figure 6 External temperature data collected by thermocouples in-line with ACP, above and below, respectively – central module. N.B. Erroneous data from TC019 has been removed.**

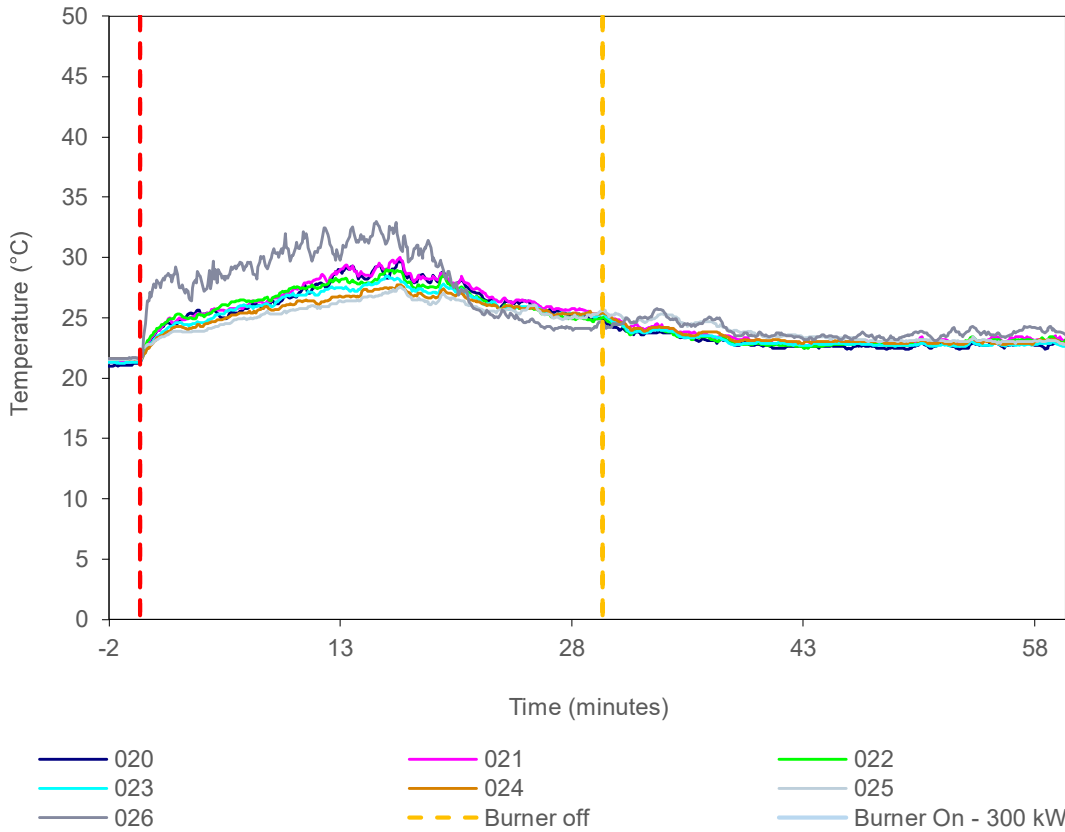

**Figure 7 External temperature data collected by thermocouples placed 60 mm from the front face of the specimen – away from burner.**

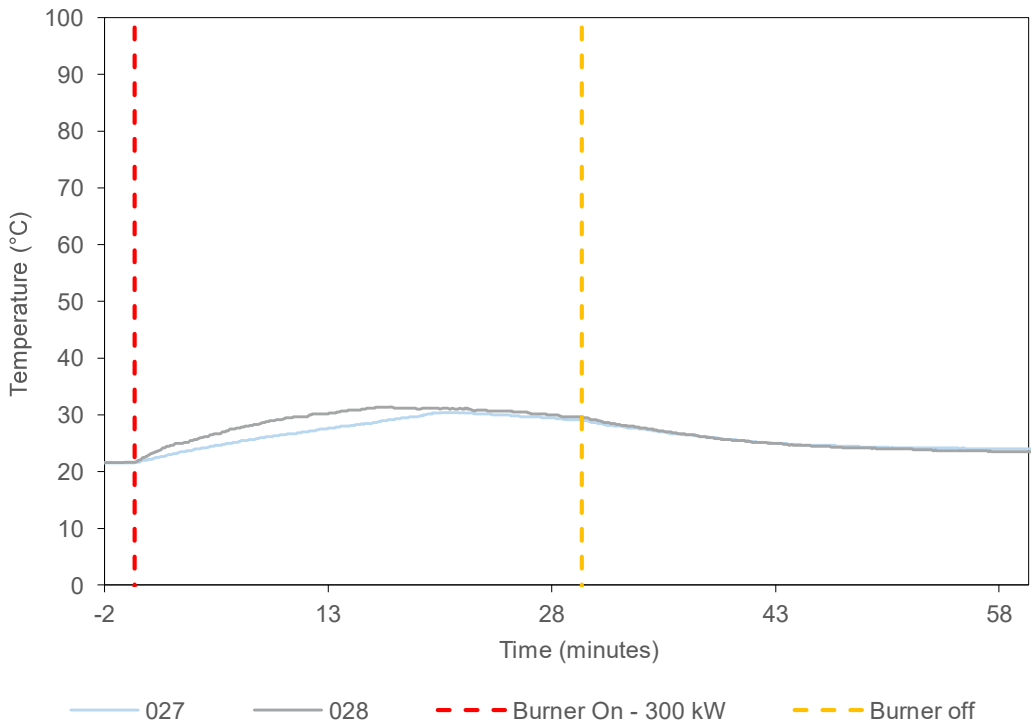

**Figure 8 External temperature data collected by thermocouples in-line with ACP, above and below, respectively – away from burner.**

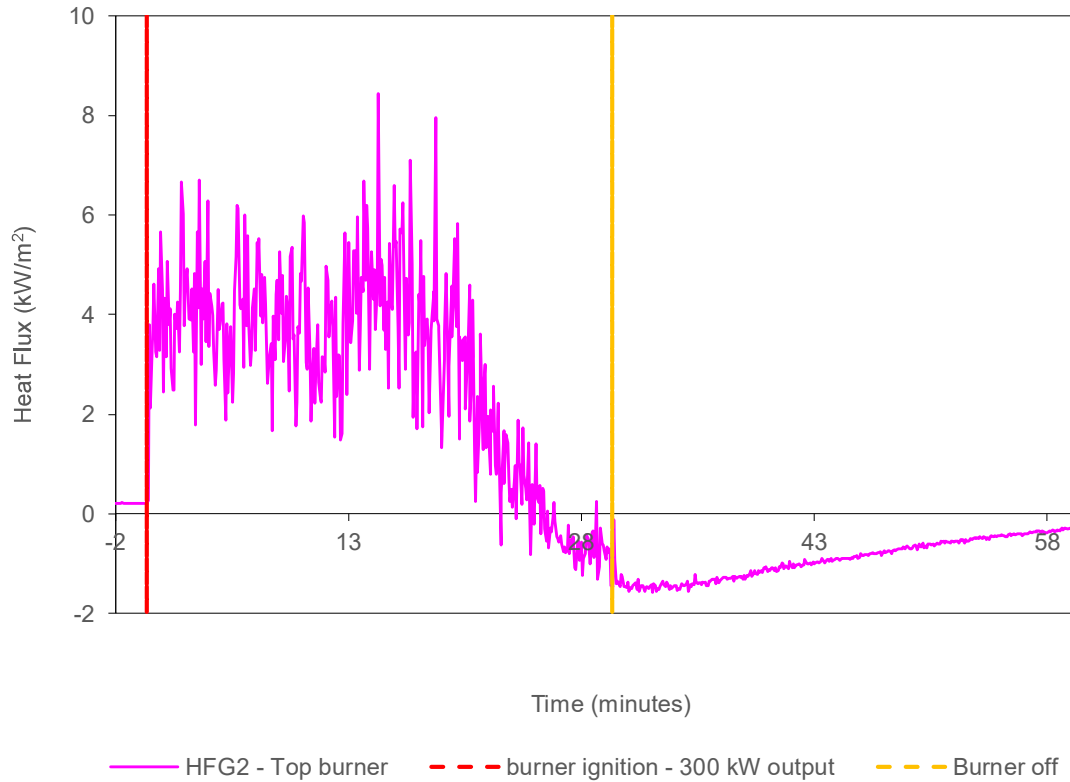

**Figure 9 Heat flux data collected by heat flux gauge at the top of the specimen above the burner.**

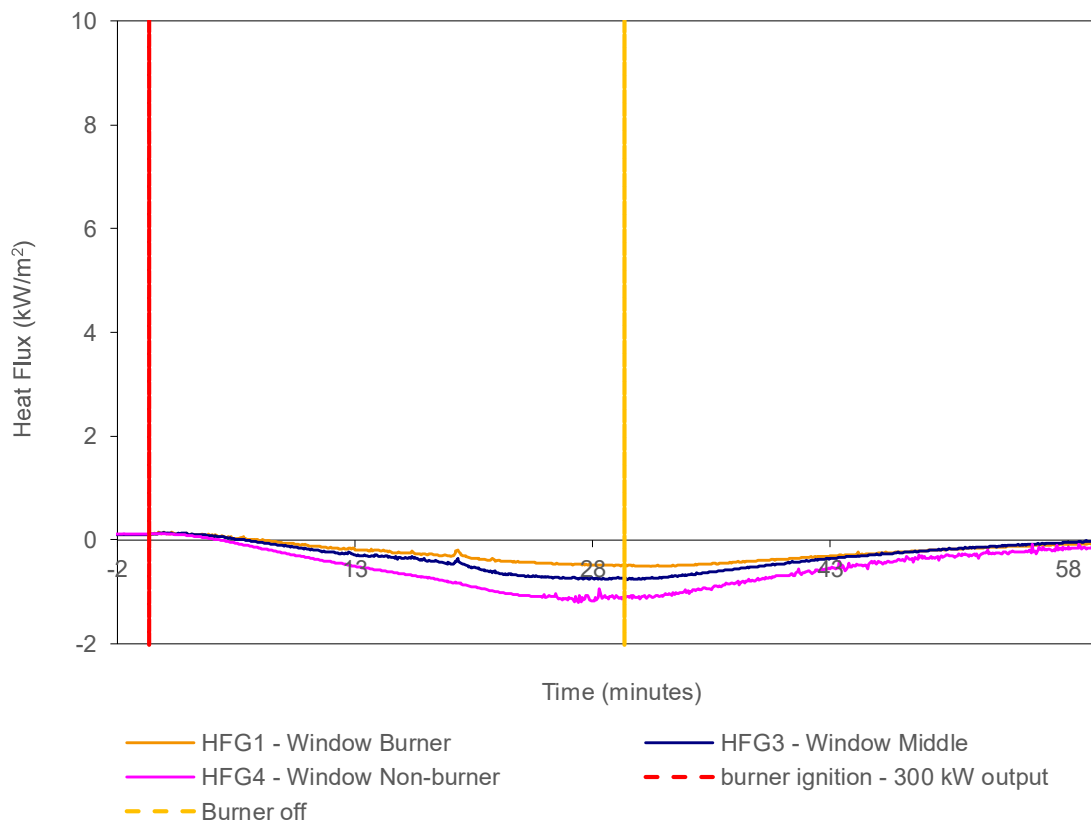

**Figure 10 Emitted heat flux measured by heat flux gauges behind the glazing units.**

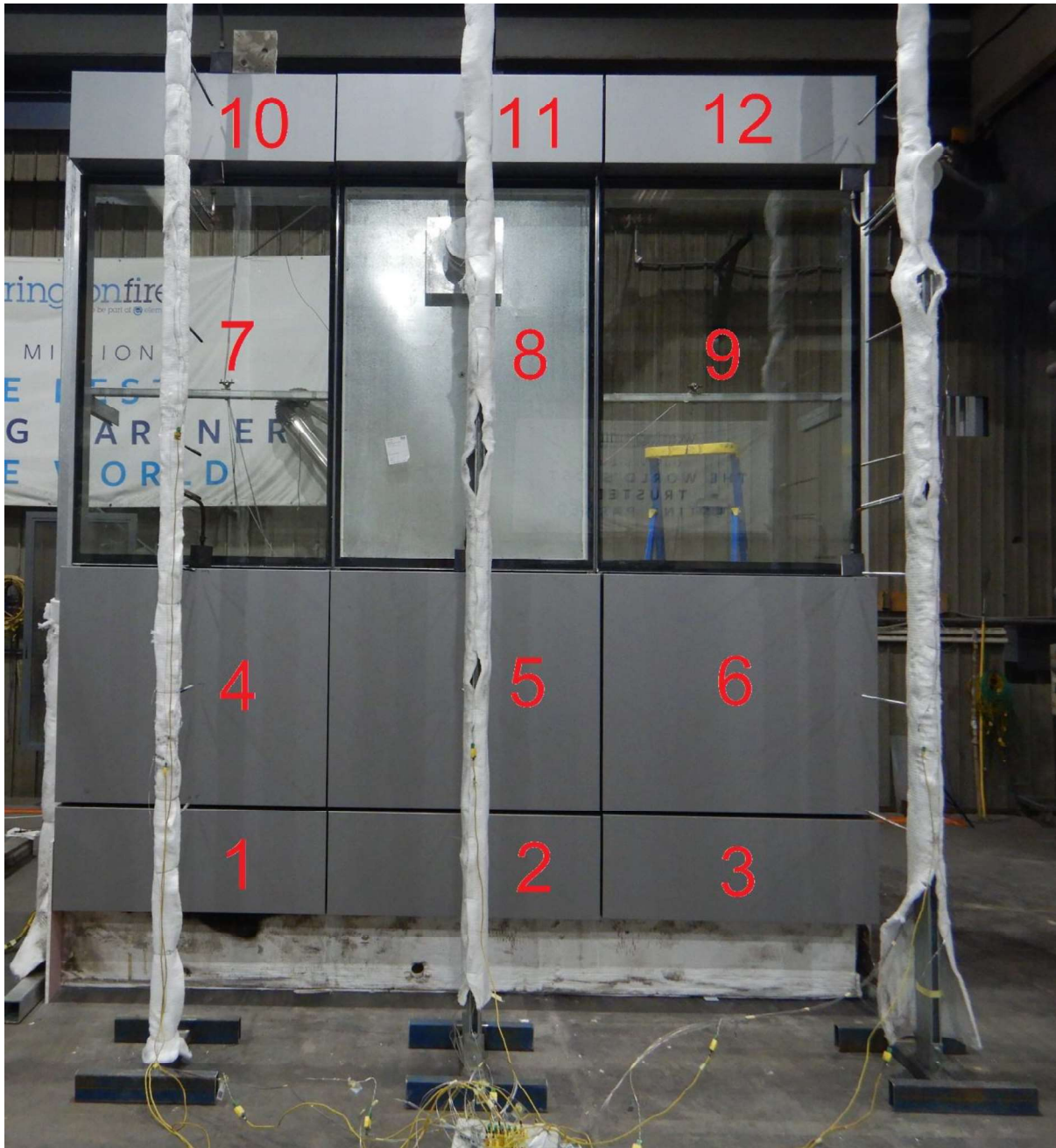

**Figure 11 Designation of section for the test observations.**

Table 4 shows the observations of any significant behaviour of the specimen during the test. Figure 10 shows the panel and glazing designations sighted in the observations.

Video recordings were also taken of the test. A copy of the video recording is available upon request from the test sponsor or by contacting Cladding Safety Victoria. The video of the test should be viewed in conjunction the contents of this report.

**Table 4 Test observations**

Time		Observation
Min	Sec	
-2	00	Data collection started.
0	00	The reaction to fire test was started with the burner ignited with a heat output set at 300 kW.
0	45	The burner flame reached above the panel of section 4. There was smoke emitting from the horizontal gaps between sections 2 & 5 and 3 & 6.
1	35	Ash from the painted panels was floating in the air.
2	17	Material was dripping from the bottom of section 1.
2	58	There was smoke from the back of section 1.
3	33	There is fire in the joint of sections 1 and 4.
4	29	The panel of section 1 had deformed.
5	05	There is smoke coming from the top of section 10.
5	24	The bottom of section 4 had partially melted and the core was exposed.
7	45	The bottom of section 1 had melted.
8	20	Smoke emissions from the back of section 1 had ceased.
10	47	The panel of section 2 deformed and bended outward.
12	26	Smoke emissions from the back of section 1 have reappeared.
13	30	There are smoke emissions between sections 5 and 6.
15	24	A big hole has formed in the panel of section 1.
16	00	The back-pan of section 1 had warped.
17	25	There is fire-penetrating through the back-pan of section 1 and 4.
18	00	A piece of the ACP has fallen off.
19	00	Flaming has propagated in the joint of between sections 2 and 5. There is flaming debris from section 4.
20	14	There is flaming debris coming through the back-pan gap on the unexposed side which has ignited the smoke seal.
20	40	Section 1 and 4 have almost fully burnt/melted/fallen away.
21	23	The back of section 4 has warped.
22	03	There is smoke emitting from between sections 7 and 8.
24	00	Section 1 has completely burnt/melted/fallen away.
24	55	There is smoke emitting from between sections 7 and 8. There is smoke from the top joint of 11 and 12.
26	47	The left frame has deformed.
30	10	The burner was turned off.
32	30	The right glazing seal has begun melting a little on the unexposed side.
38	00	Flaming in the cavity of sections 1 and 4 has decreased. Also, flaming of the debris below section 1 has decreased.
56	00	All signs of flaming are non-existent.
60	00	The test was ended.

## **5. Application of test results**

### **5.1 Test limitations**

The results of these fire tests may be used to directly assess fire hazard, but it should be recognised that a single test method will not provide a full assessment of fire hazard under all fire conditions.

These results only relate to the behaviour of the specimen of the element of construction under the particular conditions of the test. They are not intended to be the sole criteria for assessing the potential fire performance of the element in use, and they do not necessarily reflect the actual behaviour in fires.

### **5.2 Variations from the tested specimen**

This report details methods of construction, the test conditions and the results obtained when the specific element of construction described here was tested following the procedure outlined in Table 2. Any significant variation with respect to size, construction details, loads, stresses, edge or end conditions is not addressed by this report.

It is recommended that any proposed variation to the tested configuration should be referred to the test sponsor. They should then obtain appropriate documentary evidence of compliance from Warringtonfire or another accredited testing authority.

### **5.3 Uncertainty of measurements**

Because of the nature of reaction to fire testing and the consequent difficulty in quantifying the uncertainty of measurements obtained from a reaction to fire test, it is not possible to provide a stated degree of accuracy of result.

## Appendix A Drawings of test assembly

The drawings of the test assembly in Figure 12 to Figure 19 were provided by the representatives of Warringtonfire. Dimensions, unless specified, are in mm.

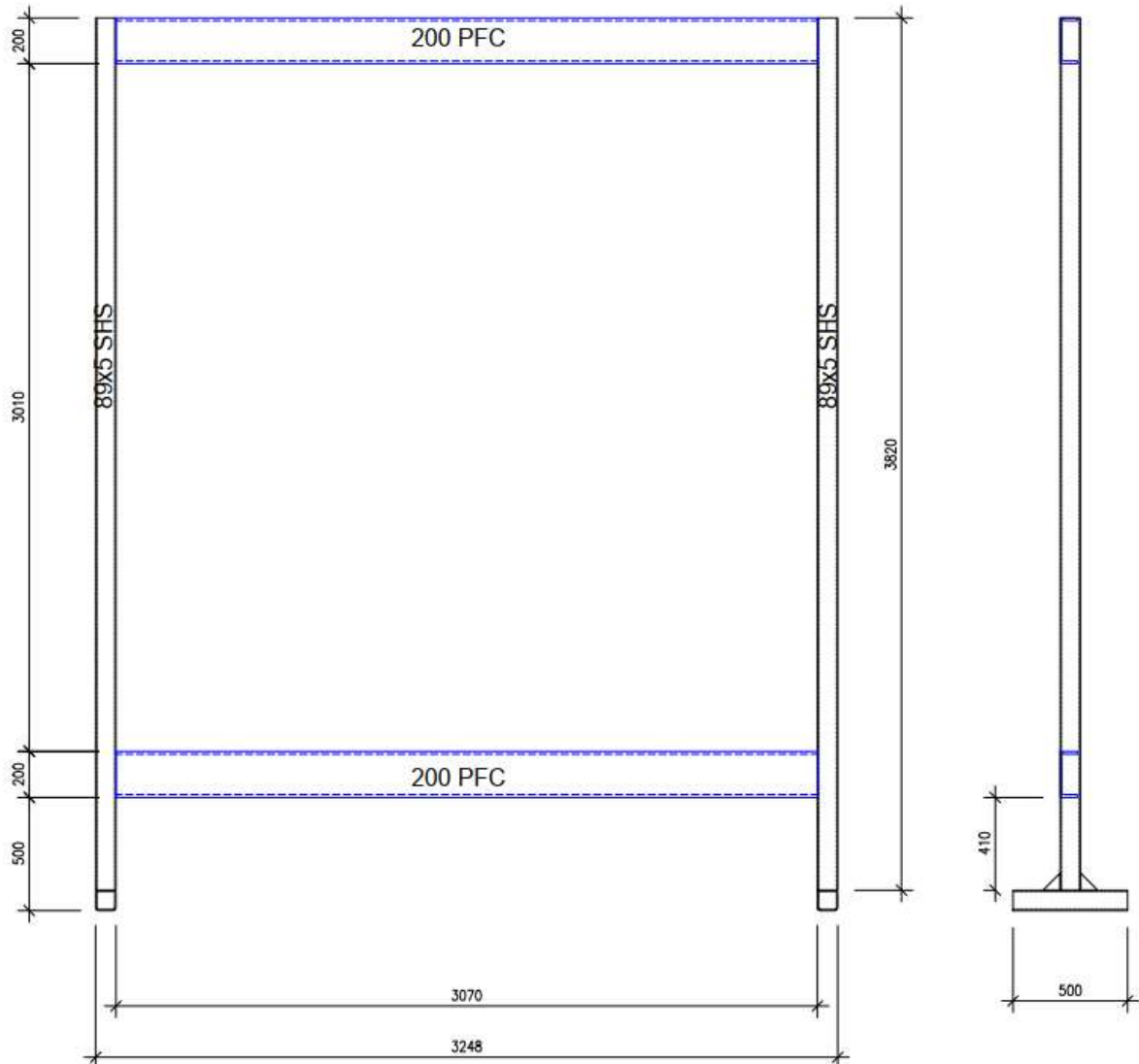

Figure 12 Elevation of rig support.

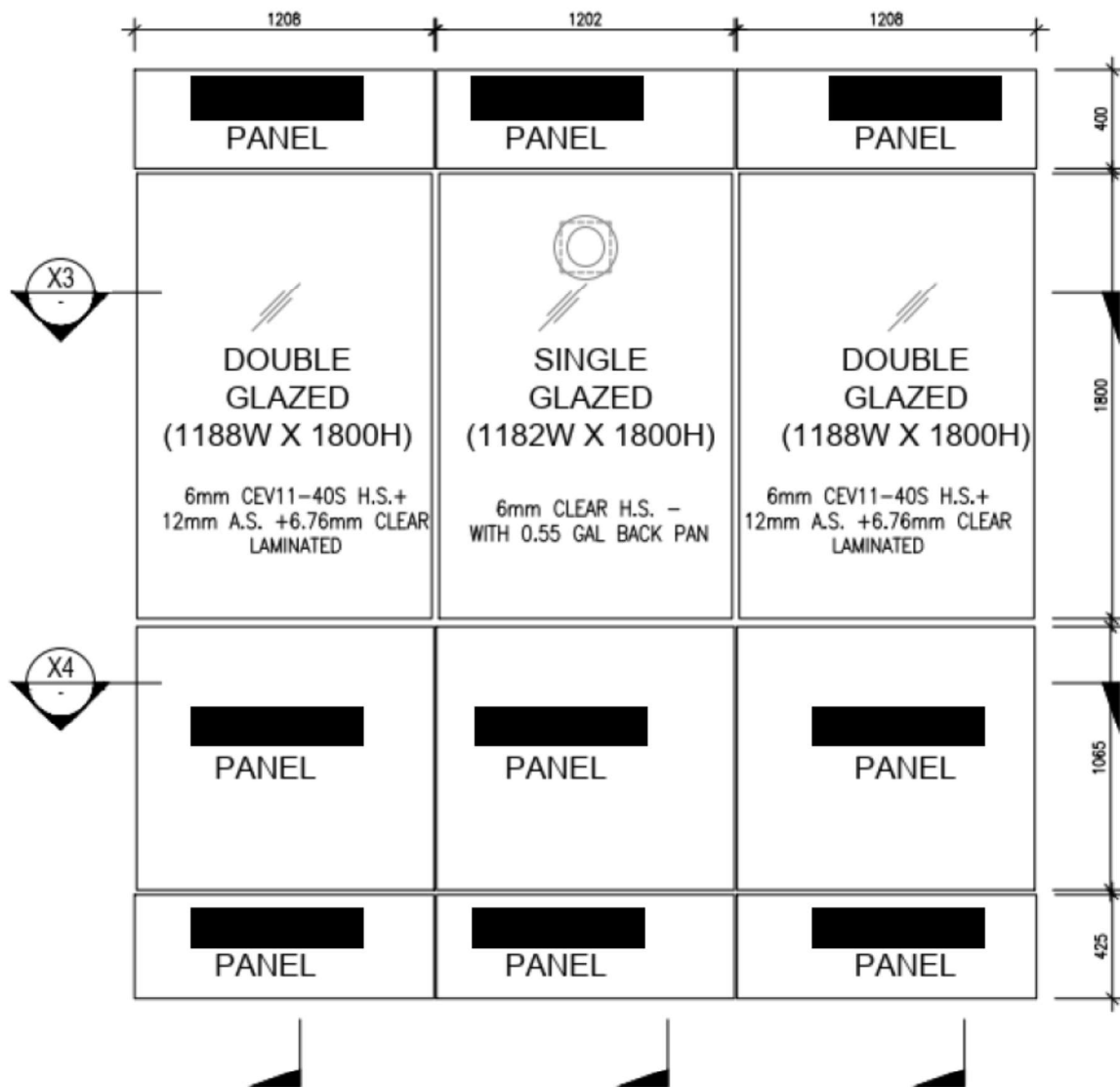

Figure 13 System assembly – Front view

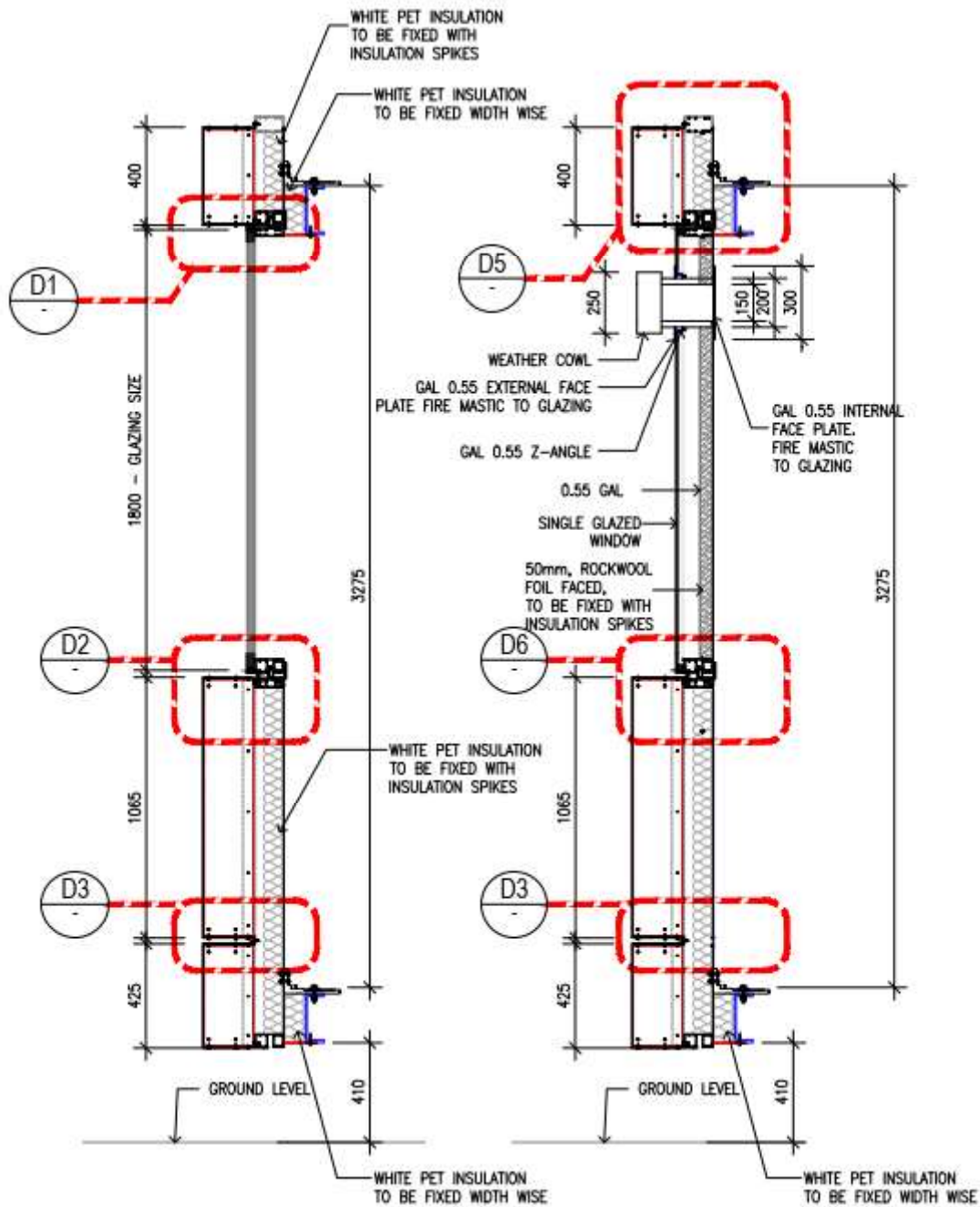

Figure 14 System assembly – vertical cross-sectional view.

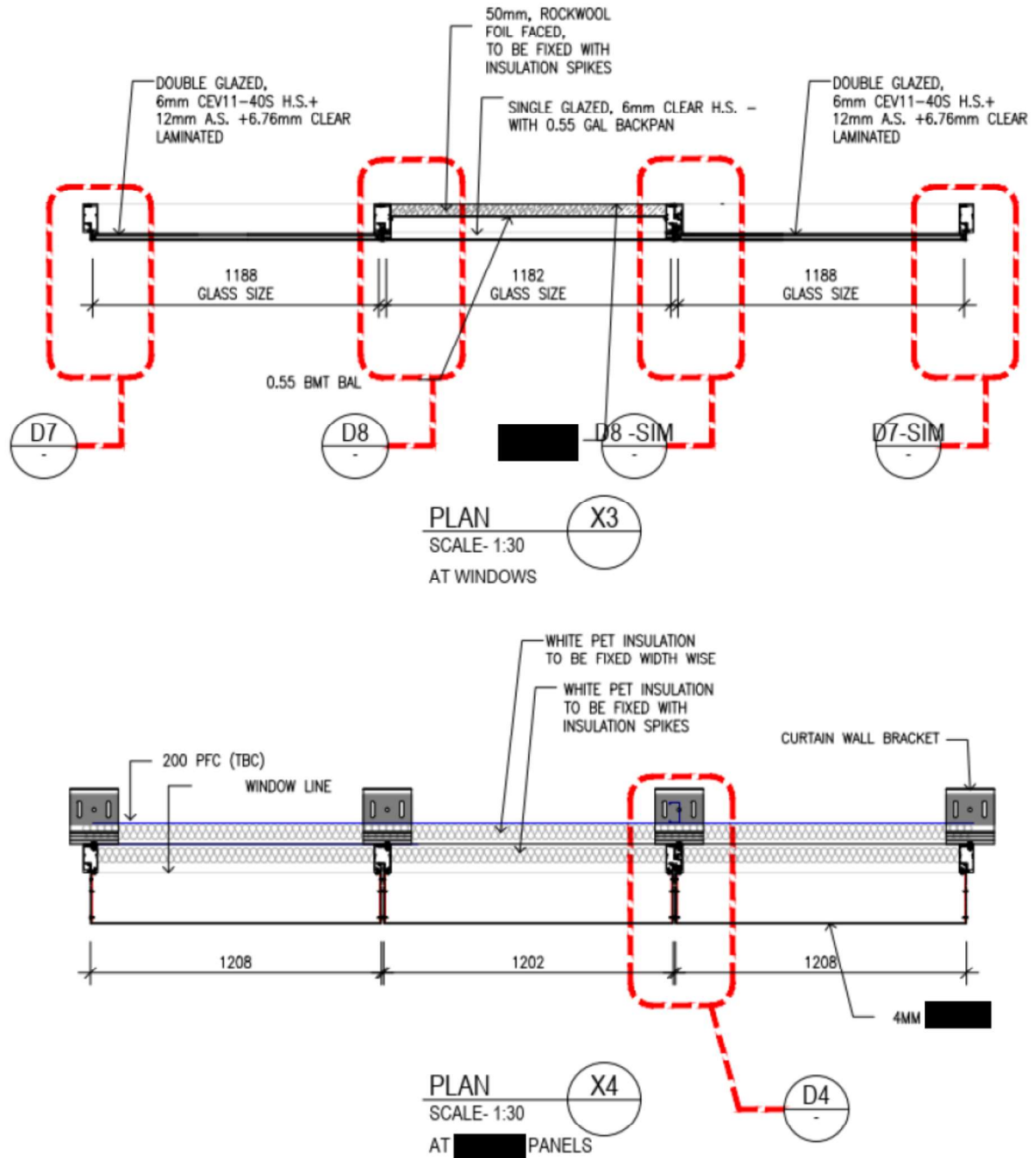

Figure 15 System assembly – vertical cross-sectional view.

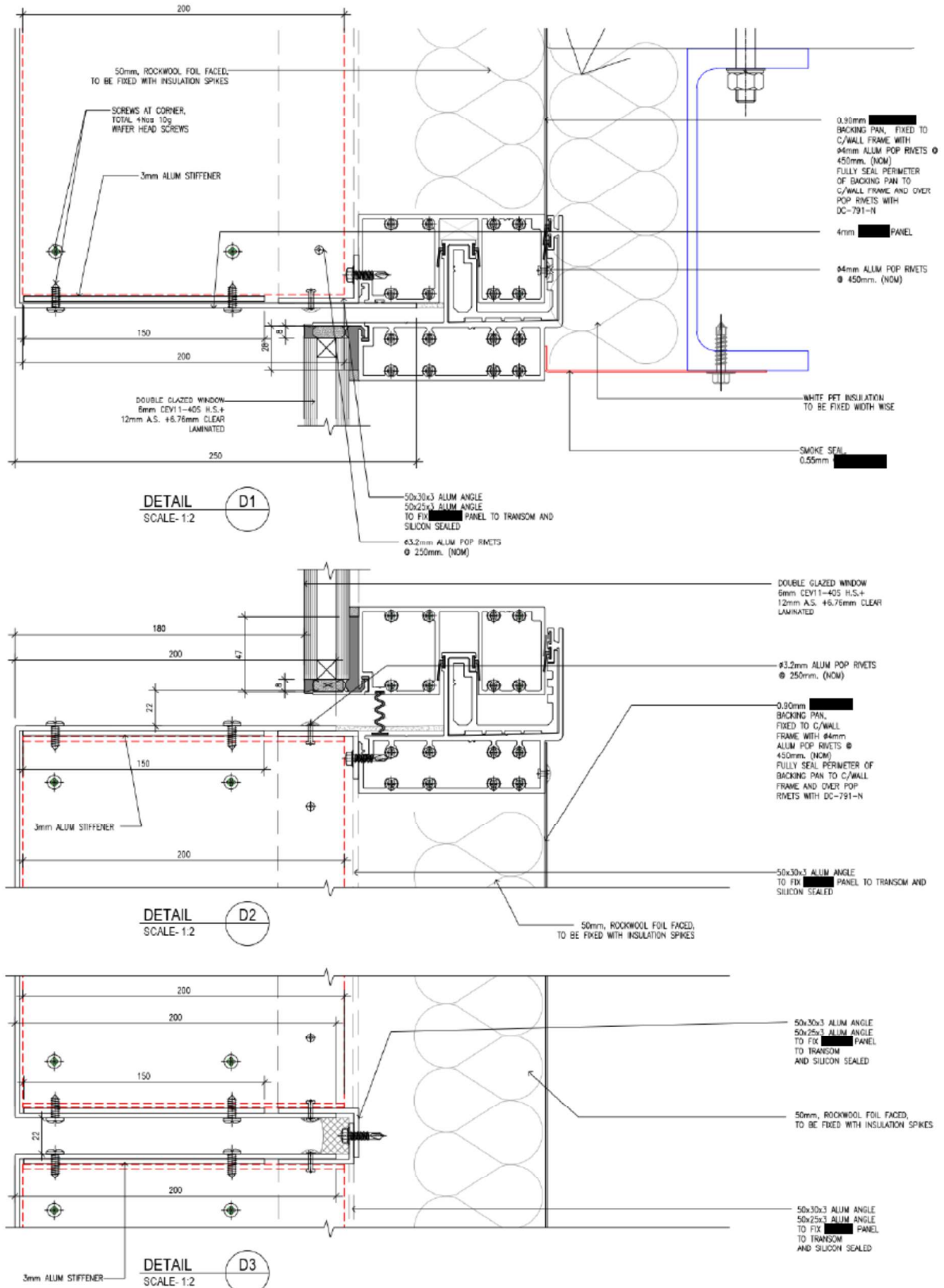

Figure 16 System assembly – Vertical cross-sectional view.

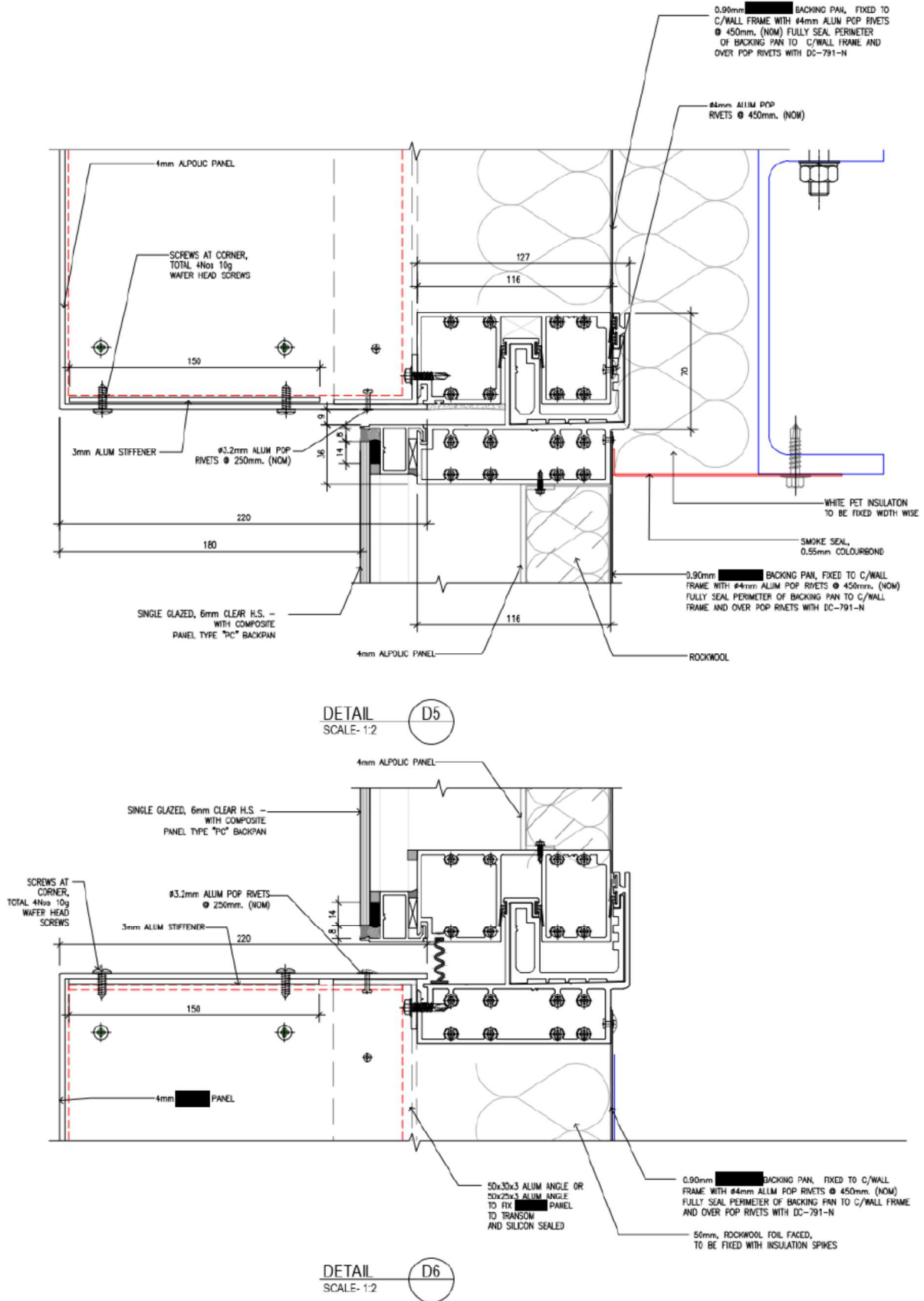

Figure 17 System assembly – Vertical cross-sectional view.

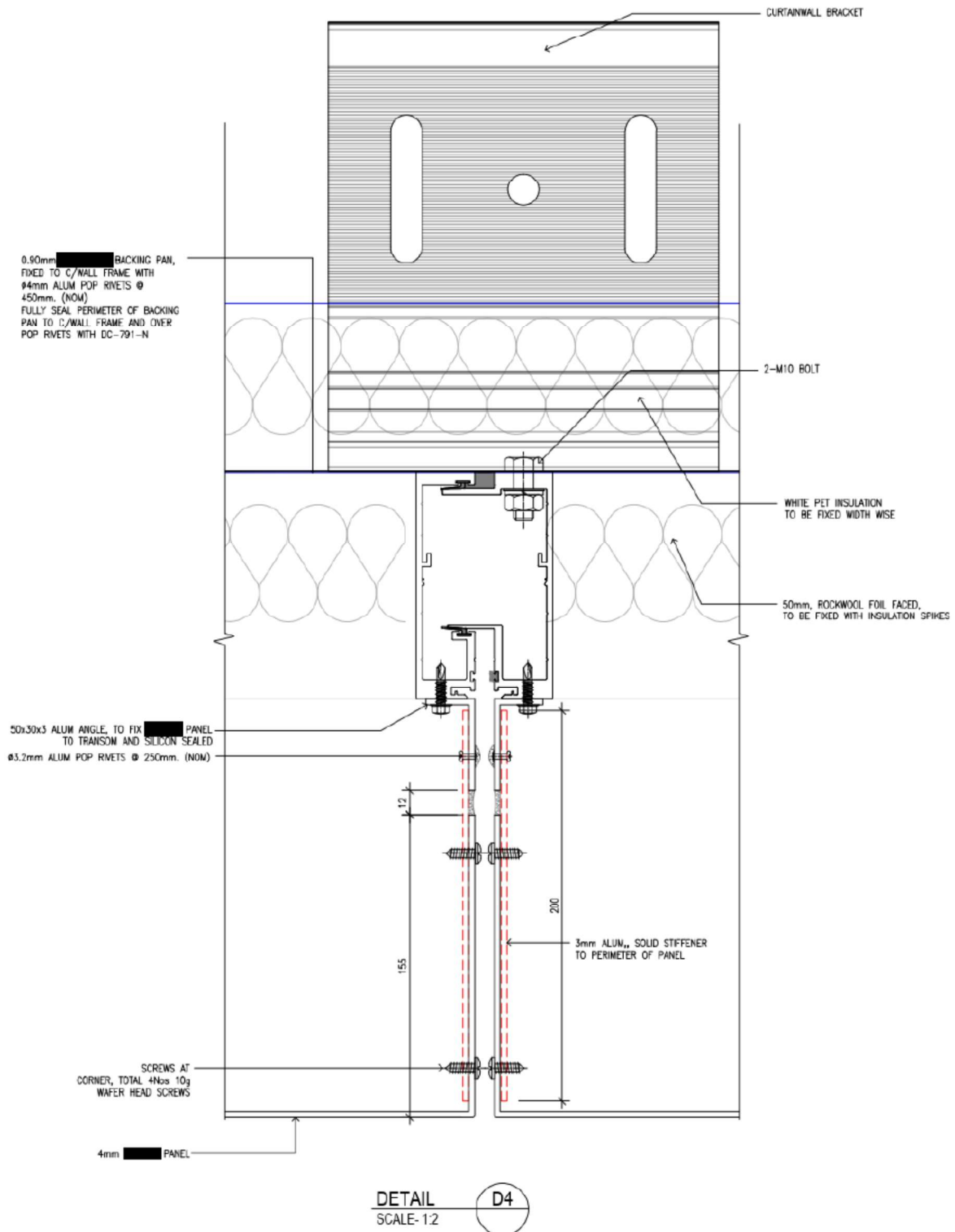

Figure 18 System assembly – vertical cross-sectional view.

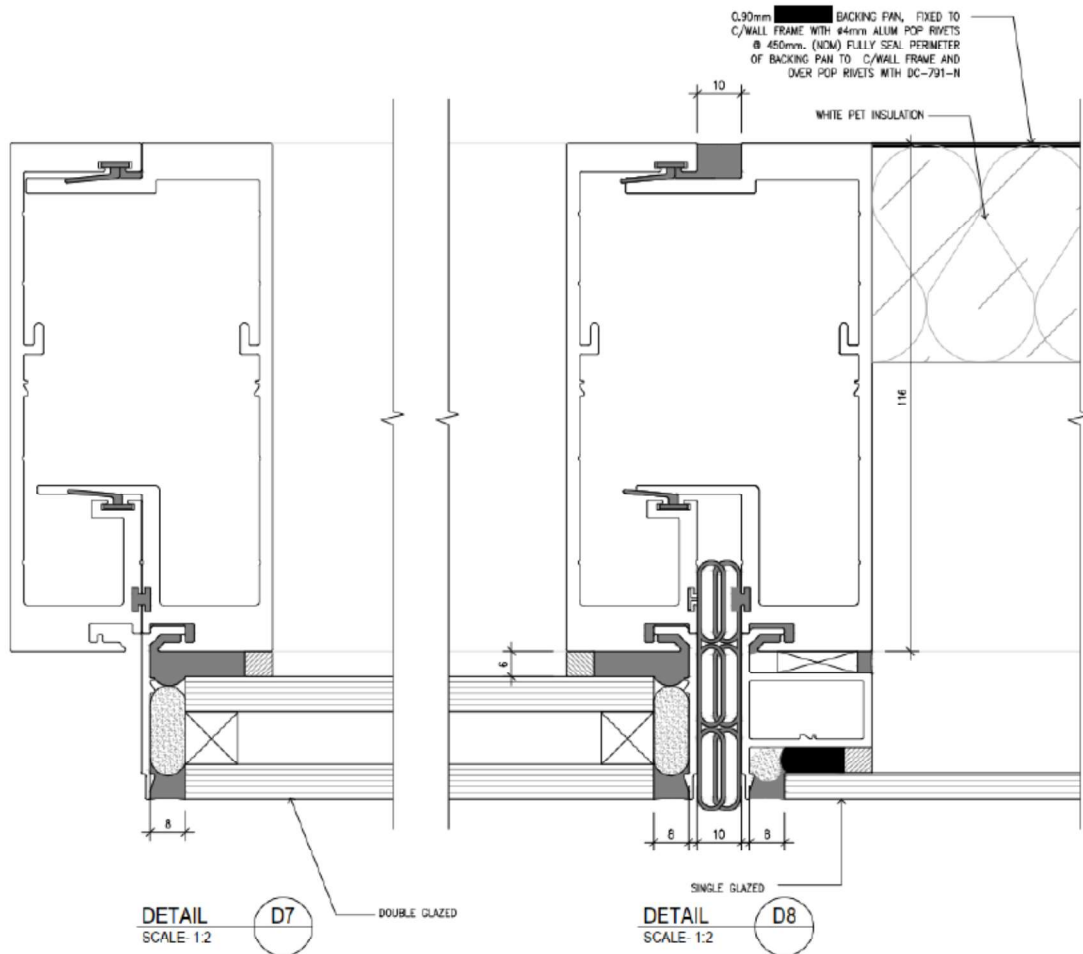

Figure 19 System assembly – vertical cross-sectional view.

## Appendix B Photographs



Figure 20 The specimen (angled - exposed side) before the reaction to fire test

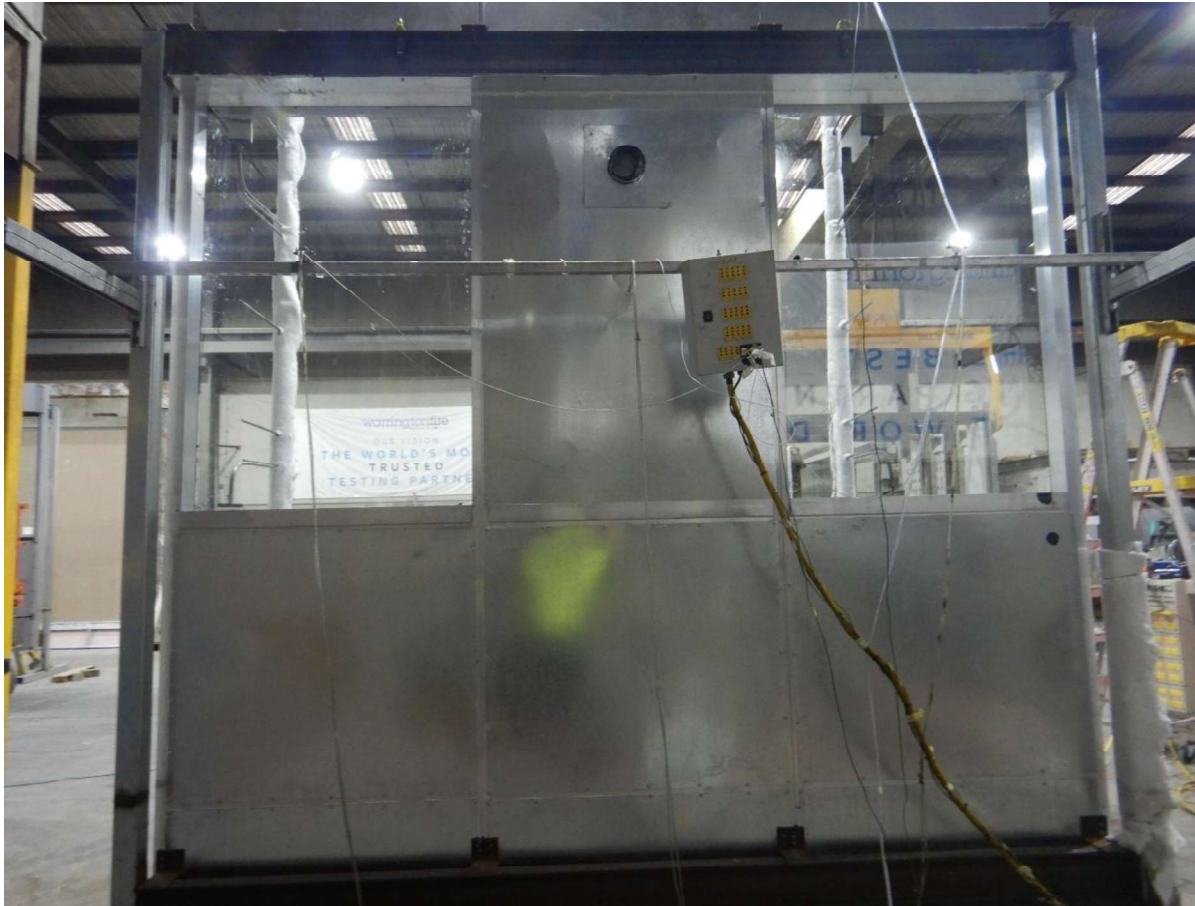

Figure 21 The specimen before the reaction to fire test - unexposed side.



Figure 22 The specimen 1 minute 55 seconds into the test (burner output at 300 kW)



Figure 23 The specimen 4 minutes 51 seconds into the test (burner output at 300 kW)



Figure 24 The specimen 9 minutes 23 seconds into the test (burner output at 300 kW)



Figure 25 The specimen 14 minutes 38 seconds into the test (burner output at 300 kW)



Figure 26 The specimen 18 minutes 8 seconds into the test (burner output at 300 kW) - unexposed side.



Figure 27 The specimen 20 minutes into the test (burner output at 300 kW).



Figure 28 **The specimen (unexposed side view) 19 minutes 39 seconds into the test (burner output at 300 kW).**



Figure 29 The specimen 20 minutes 13 seconds into the test (burner output at 300 kW).



Figure 30 The specimen 21 minutes 48 seconds into the test (burner output at 300 kW).



Figure 31 The specimen 23 minutes 41 seconds into the test (burner output at 300 kW).



**Figure 32 The specimen 25 minutes 57 seconds into the test (burner output at 300 kW) – unexposed side.**



Figure 33 The specimen 29 minutes into the test.



Figure 34 **The specimen 30 minutes 12 seconds into the test – just after burner is turned off.**



Figure 35 The specimen 30 minutes 20 seconds into the test (burner off).



**Figure 36 The specimen 30 minutes 39 seconds into the test (burner off) – unexposed side.**



Figure 37 The specimen 32 minutes 22 seconds into the test (burner off).



Figure 38 The specimen 34 minutes 18 seconds into the test (burner off).



Figure 39 The specimen at end of test – exposed side.

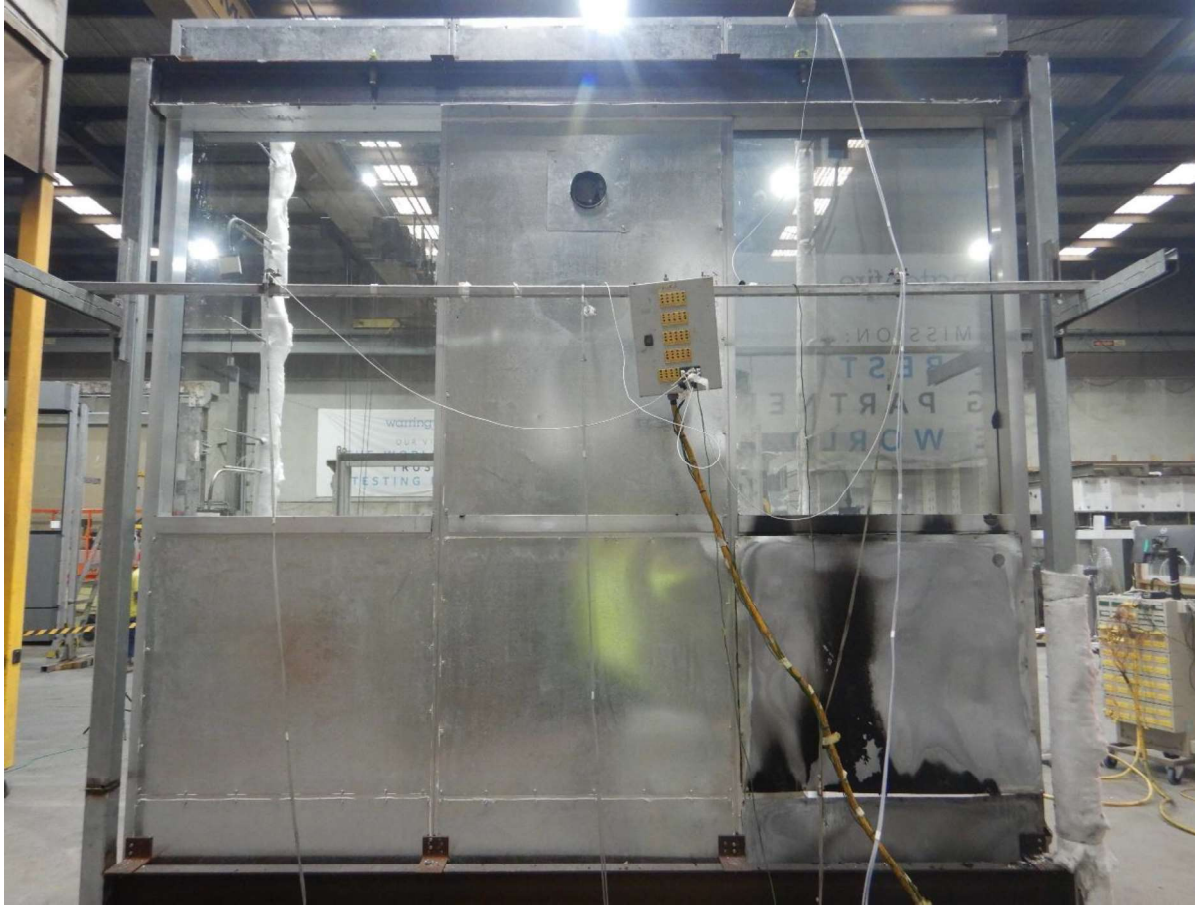

Figure 40 The specimen at end of test – unexposed side.

## Appendix C Chemical Analysis Results

Mineral content	Report No.: 22155	Site sample #1 Report No.: 202212	Site sample #2 Report No.: 202212
	Composition of the ash - %		
Mineral content	46.7	47.2	47.1
Alumina	98.6	96.7	96.5
Sodium oxide	0.46	0.45	0.49
Iron oxide	<0.01	<0.01	<0.01
Titanium oxide	<0.01	<0.01	<0.01
Calcium oxide	0.02	<0.01	<0.01
Nickel oxide	<0.01	<0.01	<0.01
Magnesium oxide	0.20	0.21	0.21
Silica oxide	<0.01	<0.01	<0.01
Sulphur trioxide	<0.01	<0.01	<0.01
Phosphorous pentoxide	<0.01	<0.01	<0.01
Potassium oxide	<0.01	<0.01	<0.01
Zinc oxide	<0.01	<0.01	<0.01
Barium oxide	<0.01	<0.01	<0.01
Manganese oxide	<0.01	<0.01	<0.01
Copper oxide	<0.01	<0.01	<0.01
Chromium oxide	<0.01	<0.01	<0.01
Lead oxide	<0.01	<0.01	<0.01
Loss on ignition (1050 °C)	Not determined due to insufficient mass of ash		



# WARRINGTONFIRE AUSTRALIA

A Jensen Hughes Company

Warringtonfire Australia Pty Ltd  
ABN 81 050 241 524

#### Perth

Suite 4.01, 256 Adelaide Terrace  
Perth WA 6000  
Australia  
T: +61 8 9382 3844

#### Canberra

Unit 10, 71 Leichhardt Street  
Kingston ACT 2604  
Australia  
T: +61 2 6260 8488

#### Melbourne

Level 4, 152 Elizabeth Street  
Melbourne Vic 3000  
Australia  
T: +61 3 9767 1000

#### Sydney

Suite 302, Level 3, 151 Castlereagh Street  
Sydney NSW 2000  
Australia  
T: +61 2 9411 5360

#### Brisbane

Suite B, Level 6, 133 Mary Street  
Brisbane Qld 4000  
Australia  
T: +61 7 3238 1700

#### Melbourne – NATA accredited laboratory

409-411 Hammond Road  
Dandenong South Vic 3175  
Australia  
T: +61 3 9767 1000

#### General conditions of use

The data, methodologies, calculations and results documented in this report specifically relate to the tested specimen/s and must not be used for any other purpose. This report may only be reproduced in full. Extracts or abridgements must not be published without permission from Warringtonfire.

All work and services carried out by Warringtonfire are subject to, and conducted in accordance with our standard terms and conditions.