



WARRINGTONFIRE  
AUSTRALIA

A Jensen Hughes Company



# Reaction to fire test report

Test standard: Ad-hoc test based on ISO 13785-1:2002

Test sponsor: Cladding Safety Victoria (CSV)

System: ACP with 100 % polyethylene core external façade cladding system (mechanically fixed)

Job number: RTF240053

Test date: 1 August 2024 Revision: RR1.0

## Quality management

Revision	Date	Information about the report			
RR1.0	4 December 2025	Description	Initial issue.		
		Name Signature	Prepared by	Reviewed by	Authorised by

Warringtonfire\* Australia Pty Ltd  
ABN 81 050 241 524

\*As used herein, The name "Warringtonfire" and its associated IP and branding is used by Warringtonfire Australia Pty Limited in Australia under licence from Warringtonfire Testing and Certification Limited (based in the UK) for a transitional period following the acquisition of Warringtonfire Australia Pty Limited. The Warringtonfire Testing and Certification Limited continues to own the rights to "Warringtonfire" and continues to operate the global "Warringtonfire business" outside of Australia.

## Contents

1.	Introduction .....	4
2.	Test specimen .....	4
2.1	Schedule of components .....	4
3.	Test procedure .....	8
4.	Test measurements and results.....	10
4.1	Test measurements.....	10
5.	Application of test results .....	14
5.1	Test limitations.....	14
5.2	Variations from the tested specimen.....	14
5.3	Uncertainty of measurements .....	14
Appendix A	Test observations .....	15
Appendix B	Drawings of test assembly .....	16
Appendix C	Instrumentation locations .....	20
Appendix D	Photographs.....	22
Appendix E	Chemical analysis results.....	32

## 1. Introduction

This report documents the findings of test one of four ad-hoc reaction to fire test for an aluminium composite panel (ACP) external façade cladding system performed on 1 August 2024. The test was based on the general principles of ISO 13785-1:2002.

Warringtonfire performed the test at the request of the test sponsor listed in Table 1.

**Table 1 Test sponsor details**

Test sponsor	Address
Cladding Safety Victoria (CSV)	717 Bourke Street Docklands VIC 3808 Australia

## 2. Test specimen

### 2.1 Schedule of components

Table 2 describes the test specimen and lists the schedule of components. These were provided by the representatives of the test sponsor and surveyed by Warringtonfire. All measurements were done by Warringtonfire – unless indicated otherwise.

Detailed drawings of the test specimen are provided in Appendix B.

**Table 2 Schedule of components**

Item	Description	
<b>Cladding</b>		
1.	Item name	ACP panelling - cassetted
	Product name	Aluminium Composite Panel - 4 mm Gloss white/Light grey
	Manufacturer/Supplier	██████████
	Note on Supply of Panel	On behalf of CSV, Warringtonfire acquired the ACP with close to 100% polyethylene core. To the best of Warringtonfire's knowledge this is a custom production which the supplier doesn't normally supply. The panels were provided on the basis that this was for research purposes and not any purpose other than fire testing.
	Material	The material was nominated as panels consisting of two layers of aluminium sheets sandwiching a layer (core) with 100 % polyethylene (PE). Analysis conducted by the analytical centre of UNSW showed that the core consisted of polyethylene (PE) - found to be 96 % w/w - whilst the remainder of the material was found to be 3.3 % inert material. Refer to Appendix E for more detailed results - Sample 24021-1.
	Construction	The panel was made using two ACP panels, measuring 1240 mm wide × 2140 mm high and 340 mm wide × 2140 mm high respectively, that had a 20 mm perimeter fold and were riveted (item 16) at nominal 250 mm centres along the shared central vertical fold to make up a 1500 mm wide × 2100 mm high assembled panel with a 20 mm perimeter fold.
	Thicknesses	Total panel thickness – 4.0 mm Core thickness – 3.0 mm Skin thickness – 0.5 mm (both)
	Batch date	2023/12/05
	Areal density	5.6 kg/m <sup>2</sup>
	Colour	Skins Exposed face – Gloss white

Item	Description	
		Unexposed face – Light grey
	Core	Black
2.	Item name	Calcium silicate board
	Product name	██████████
	Size	1200 mm wide × 3600 mm long × 20 mm thick (uncut)
	Batch number	BA900232 1809001818014001
3.	Item name	Fire rated plasterboard
	Product name	████████████████████
	Manufacturer	██████████
	Size	1200 mm wide × 3600 mm long × 13 mm thick (uncut)
	Batch number	9314450006293
<b>Framing</b>		
4.	Item name	Top track/base track
	Material	Steel
	Size	92 mm × 1500 mm × 40 mm, 1.15 mm B.M.T.
	Manufacturer	██████████
	Batch number	932584201026
5.	Item name	Steel stud
	Size	92 mm × 2100 or 2600 mm × 40 mm, 1.15 mm B.M.T.
	Manufacturer	██████████
	Batch number	932584201031
	Installation	Studs at max. 600 mm
6.	Item name	Steel nogging
	Size	92 mm × 580 mm × 40 mm, 1.15 mm B.M.T.
	Manufacturer	██████████
	Batch number	932584200860
	Installation	Running horizontally at mid height
<b>Angles</b>		
7.	Item name	Equal angle
	Size	20 mm × 20 mm × 3600 mm, 1.6 mm thick
	Manufacturer/Supplier	██████████
	Material	Aluminium
	Installation	Used to secure the ACP to the 92 mm framing. The angle was screw fixed to both ACPs and the 92 mm framing using cassette screws (item 13) at nominal 250 mm and 500 mm centres respectively.
8.	Item name	Flashing
	Size	1500 mm long × 150 mm tall × 120 mm deep × 0.55 mm thick
	Manufacturer	██████████
	Material	Galvanised steel Z275

Item	Description	
	Installation	Used to provide protection to the ACP cladding to test rig bottom joint. The 150 mm flange was fixed through the plasterboard patch strip (item 3) to the calcium silicate board (item 2) of the back blanking wall with patch screws (item 12) at nominal 300 mm centres. The 120 mm flange was fixed to the underside of the specimen framing at nominal 300mm centres with framing screws (item 10).
9.	Item name	Top hat stiffeners
	Manufacturer/Supplier	██████████
	Material	Galvanised steel
	Size	25×25×50×25×25 mm × 1200 mm long
	Installation	Fixed horizontally to the studs (item 5) at nominal 600 mm centres with two framing screws (item 10) per stud. They were adhered to the unexposed side of the ACPs panels with a single strip of tape (item 14) up the middle with two beads of adhesive (item 15) either side of it.
<b>Fixings</b>		
10.	Item name	Framing screws
	Description	10g × 16 mm, flathead, self-drilling screws
	Manufacturer	██████████
	Installation	Used to fix the framing (items 4,5 and 6) together and to secure the stiffeners (item 9) to the framing.
11.	Item name	Board screws
	Description	6g × 32 mm, bugle head, drill point, fine thread screws
	Manufacturer	██████████
	Installation	Used to fix the calcium silicate boards (item 2) and plasterboard sheets (item 3) to the steel framing (item 5) at 300 mm centres.
12.	Item name	Patch screws
	Description	6g × 32 mm, bugle head, needle point, fine thread screws
	Manufacturer	██████████
	Installation	Used to fix the plasterboard patches (item 3) to the calcium silicate board (item 2) and secure the flashing (item 8).
13.	Item name	Cassette screws
	Description	10g × 16 mm, flathead, self-drilling screws
	Manufacturer/Supplier	██████████
	Installation	Use to secure the ACP (item 1) to the angles (item 7).
14.	Item name	Double sided tape
	Description	12 mm wide × 2 mm thick ██████████ Tape
	Manufacturer	██
	Installation	Used to hold the ACP panels (item 1) to the stiffeners (item 9) while the adhesive (item 15) cured.
15.	Item name	Adhesive sealant
	Description	██████████
	Batch number	4823602348
	Manufacturer	██████████

Item	Description	
	Installation	Used to fix the ACP panels (item 1) to the stiffeners (item 9).
16.	Item name	Rivets
	Description	Ø4 mm × 13 mm aluminium rivets
	Manufacturer/supplier	██████████
	Installation	Used to fix the ACP panel (item 1) segments together at nominal 250 mm centres.
<b>Installation method</b>		
Specimen wall frame	The specimen wall frame consisted of steel framing (items 4, 5 and 6) fixed together using framing screws (item 10). It was clad on the back face with plasterboard (item 3) secured at 300 mm centres with board screws (item 11).	
Blanking walls	The test rig blanking walls consisted of three sperate assemblies of steel framing (items 4, 5 and 6) fixed together using framing screws (item 10) and clad on the fire exposed side with calcium silicate board (item 2). The two sides and the back where fixed to one another to form an alcove nominally 1500 mm wide by 888 mm deep.	
Overall size	Back blanking wall	1500 mm wide × 2600 mm tall
	Side blanking walls	1000 mm wide × 2500 mm tall
	Specimen	1500 mm wide × 2100 mm tall
ACP cladding	The exposed face of the specimen was clad with casseted ACP (item 1) that was folded nominally 20 mm in and fixed to equal angles (item 7) using cassette screws (item 13) at nominal 250 mm centres to form a nominally 25 mm deep cassette. Two ACP panel segments were joined to one another using rivets (item 16) to form the larger overall ACP assembly. The face of the ACP was in line with the edge of the flashing (item 8).	

### 3. Test procedure

Table 3 details the test procedure for this reaction to fire test.

**Table 3 Test procedure**

Item	Detail	
Statement of compliance	<p>The ad-hoc test - based on ISO 13785-1:2002 - was undertaken to determine the reaction to fire properties of an external wall cladding material, exposed to heat from a simulated external fire. The test utilised a burner based on the requirements of ISO 13785-1:2002.</p> <p>The instrumentation used to collect and analyse the products of combustion was based on ISO 9705-1:2016.</p>	
Supplementary standard	<ul style="list-style-type: none"> <li>AS ISO 9705:2003 (R2016)</li> <li>ISO 9705-1:2016</li> </ul>	
Sampling / specimen selection	<p>The laboratory was not involved in sampling or selecting the test specimen for the reaction to fire test.</p> <p>The results obtained during the test only apply to the test samples as received and tested by Warringtonfire.</p>	
Ambient laboratory temperature	Start of the test	10 °C
	Minimum temperature	10 °C
	Maximum temperature	11 °C
Initial horizontal wind speed	0.3 m/s (measured at a horizontal distance of 500 mm away from the façade face before the test)	
Test duration	19 minutes at which a heat release rate of 2.5 MW was recorded. The test was stopped due to safety concerns.	
Instrumentation and equipment	<ul style="list-style-type: none"> <li>6 mineral insulated metal sheathed (MIMS) Type K thermocouples with an overall diameter of 1.5 mm with the measuring junction insulated from the sheath were positioned at various heights, 50 mm in front of the outer face of the test specimen along its vertical centreline. Refer to Figure 13 and Figure 14 in Appendix C for details on positioning.</li> <li>3 MIMS Type K thermocouples with an overall diameter of 1.5 mm with the measuring junction insulated from the sheath were positioned at various heights at mid-depth of the framing cavity of the test specimen. Refer to Figure 13 and Figure 14 in Appendix C for details on positioning.</li> <li>The fire source was a propane (95 % purity) gas fuelled box burner; 1.2 m wide × 0.1 m deep × 0.15 m tall. The burner was located on the floor in front of the specimen, with the back edge of the burner in line with the exposed face of the specimen.</li> <li>The incident heat flux 50 mm above and in line with the exposed face of the test specimen was measured using a Schmidt-Boelter type heat flux gauge with a range of 0 - 50 kW/m<sup>2</sup>.</li> <li>The products of combustion were collected in an exhaust hood located centrally above the exposed face of the tested specimen. The hood was connected to an exhaust duct 400 mm in diameter, which had instruments inside to measure the conditions and properties of the combustion products during the test. The hood had specifications based on those given in AS ISO 9705:2003 (R2016), with the only differences being that all four sides had 1 m steel sheet extensions, and there was no fire test room.</li> <li>The volume flow rate was determined using a bidirectional pressure probe attached to a differential pressure transmitter together with a type K MIMS thermocouple positioned near the probe.</li> <li>Smoke obscuration measurements were made using a helium-neon laser smoke photometer, as outlined in Annex H of ISO 9705-1:2016.</li> </ul>	

Item	Detail
	<ul style="list-style-type: none"> <li>The temperature of the exhaust stream near the light beam was measured using a type K MIMS thermocouple.</li> <li>An exhaust sampling probe sampled the combustion products which were then analysed by a gas purity analyser. The oxygen concentration during the test was determined by a paramagnetic oxygen sensor and the carbon monoxide and carbon dioxide concentrations were determined using an infrared sensor.</li> <li>The horizontal wind speed will be measured using a hot wire anemometer at a horizontal distance of 500 mm away from the centre of the exposed face of the tested specimen.</li> <li>A Fourier Transform Infrared Spectroscopy (FTIR) gas analyser was connected to the exhaust duct, and operated by representatives of the test sponsor to sample the products of combustion during the test.</li> </ul>
System response	<p>A step calibration test was carried out to determine the system response time. The gas burner was placed centrally and 1 m below the exhaust hood by subjecting it to a stepwise change in heat release shown in Table 4. Data from instruments was collected and analysed every 3 seconds.</p> <p>At steady state conditions, the difference between the mean rate of heat release over 1 minute calculated from the measured oxygen consumption and that calculated from the metered gas output did not exceed <math>\pm 5\%</math> for each level of heat output – and therefore complied with the requirements of Section 10.1 of AS ISO 9705:2003 (R2016).</p> <p>The system response time was determined by calculating the average time taken for the measured rate of heat release to be within 10% of the metered gas calculated rate of heat release. System response data is listed in Table 4 and the system response has been calculated to be 24 s</p>
Test procedure	<ul style="list-style-type: none"> <li>At least two minutes of baseline data was collected prior to burner ignition. Temperature and heat flux data was collected at 5 s intervals, while the combustion products sampling data was collected at 3 s intervals.</li> <li>The heat output from the burner was held at 100 kW for 15 minutes, then 300 kW for the following 4 minutes before ending the test due to safety concerns.</li> </ul>

**Table 4 Response time measurements during the step calibration test**

Step	Target heat output (kW)	Metered gas output (kW)	Heat measured (kW)	Variance (%)	Response time (s)
1-2	100	98.8	100.0	1.3%	27
2-3	300	297.6	309.9	4.1%	21
3-4	100	98.9	96.2	-2.8%	24

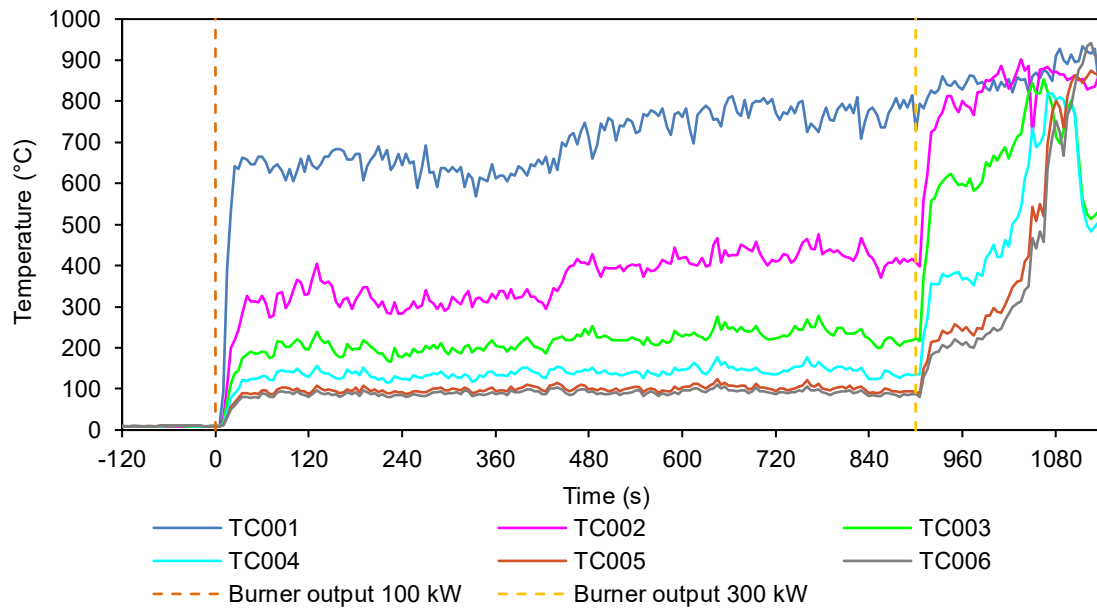
## 4. Test measurements and results

### 4.1 Test measurements

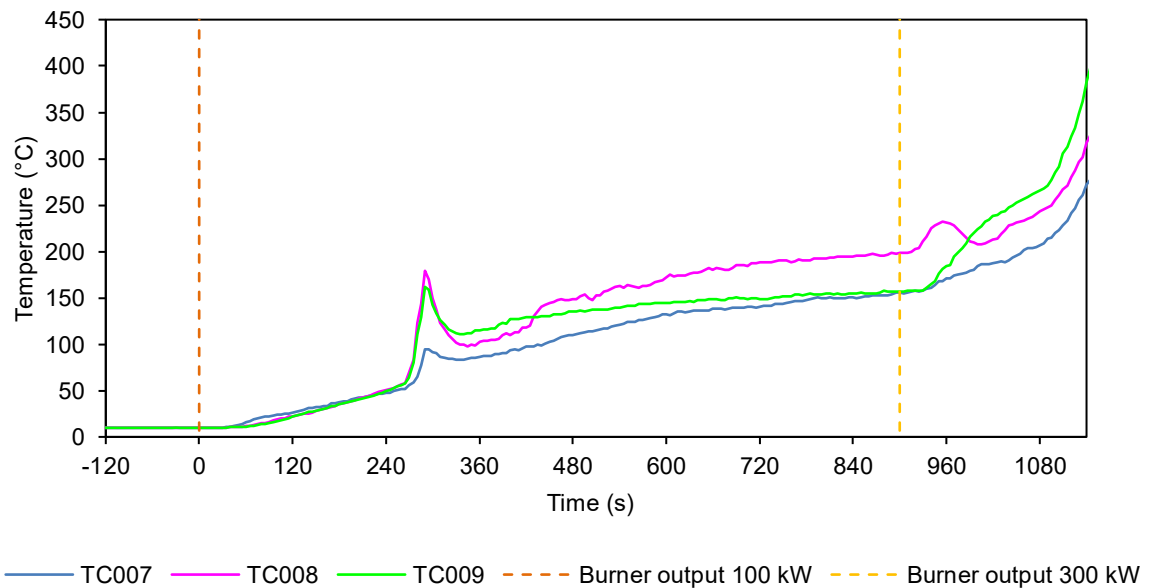
The measurements taken for the heat flux, volume flow rate, heat release rate, temperatures and light obscuration – along with the production rates of carbon monoxide and carbon dioxide – are summarised below.

Table 5 in Appendix A includes observations of any significant behaviour of the specimen.

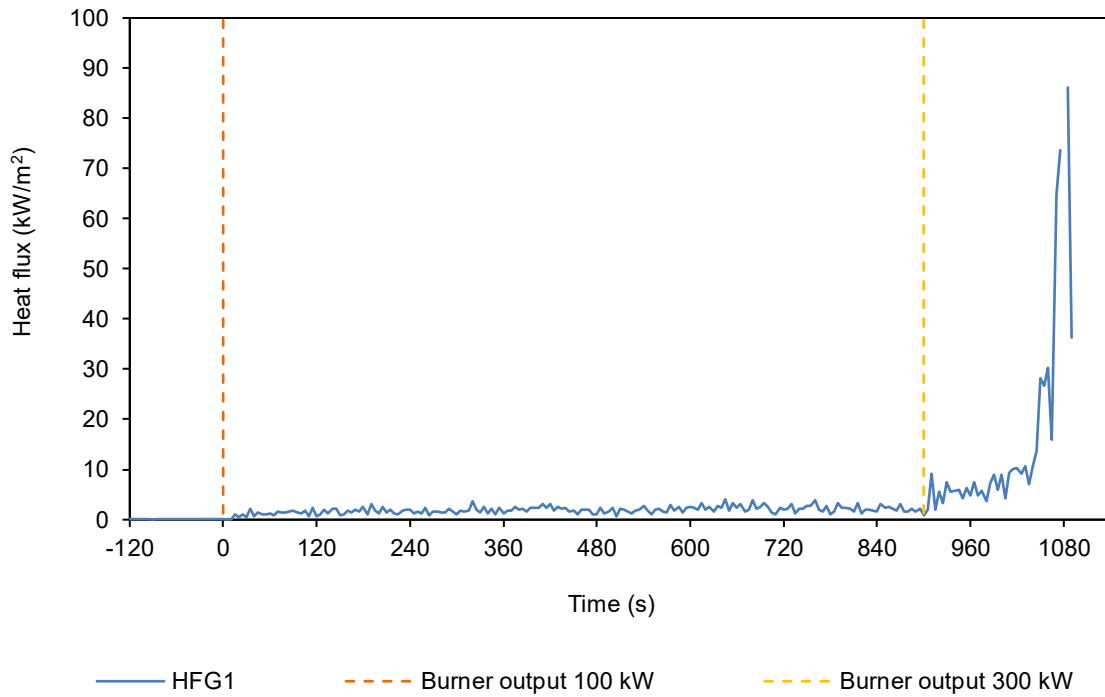
Photographs of the specimen are included in Appendix D.



**Figure 1 50 mm from the exposed face – Temperature vs time**

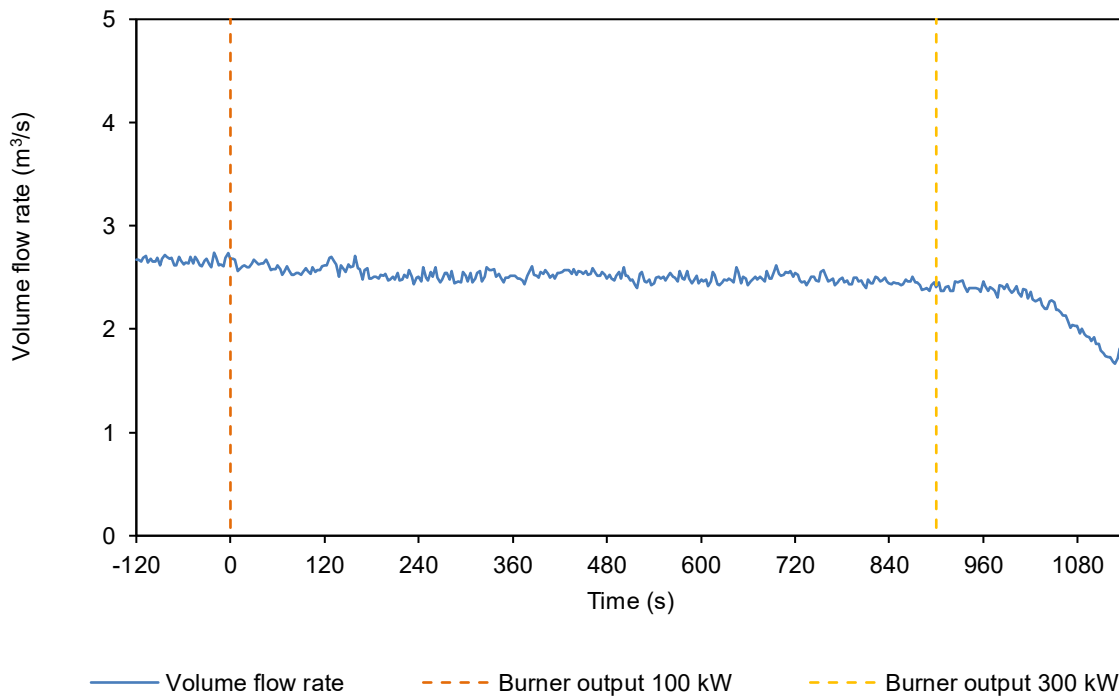


**Figure 2 Cavity – Temperature vs time**

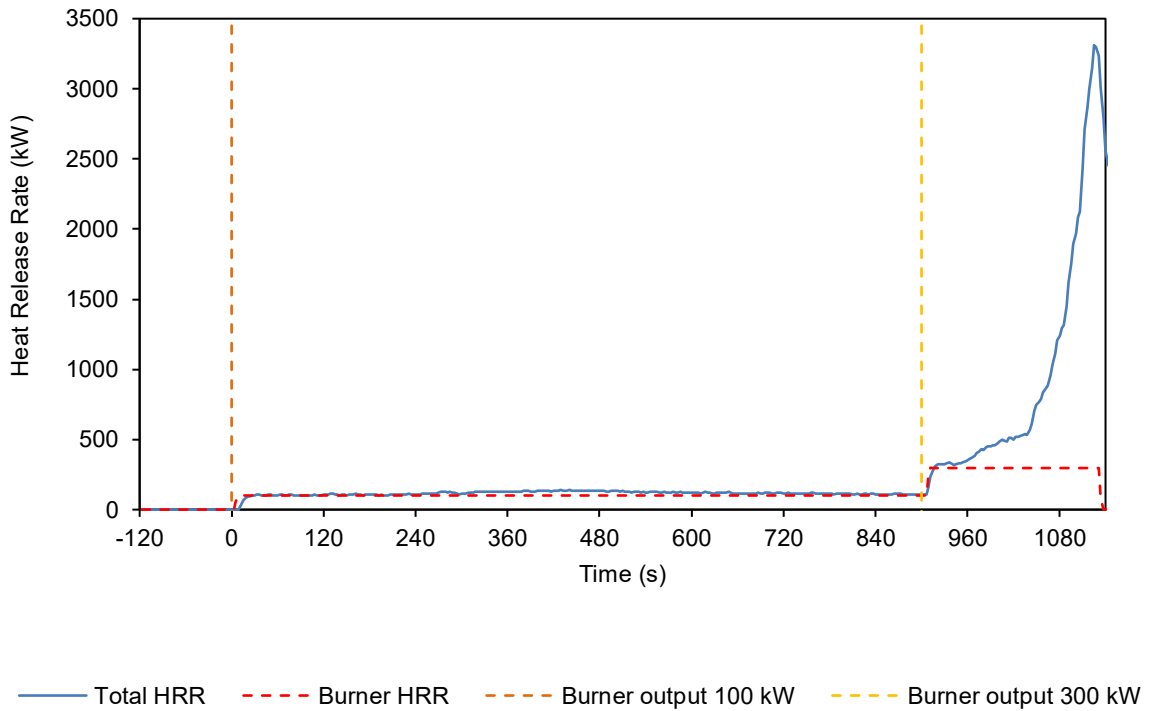


**Figure 3 Heat flux vs time**

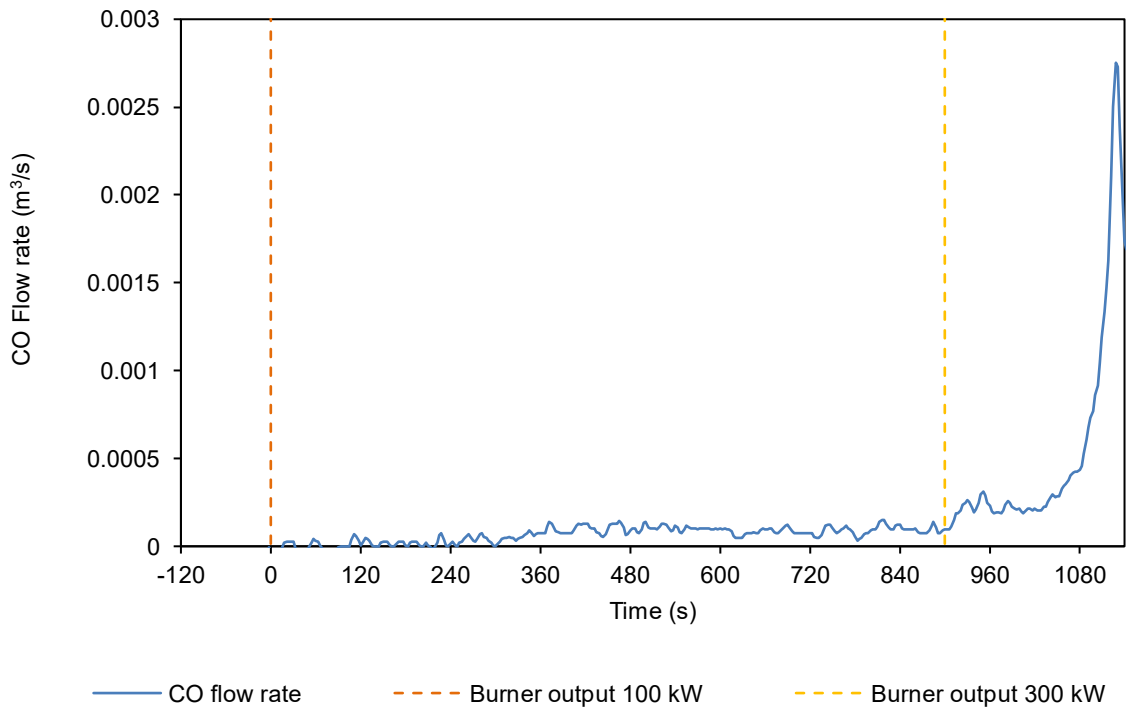
Note: Readings that exceeded 80-90 kW/m<sup>2</sup> were outside of measurement range and have been omitted.



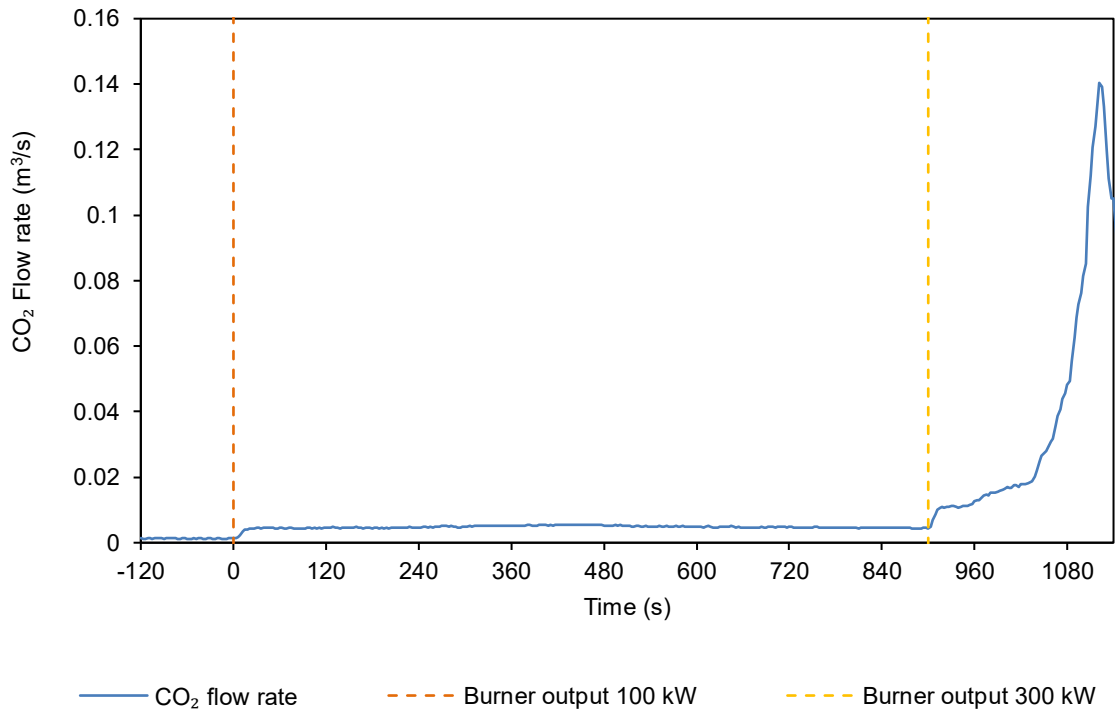
**Figure 4 Volume flow rate in duct vs time**



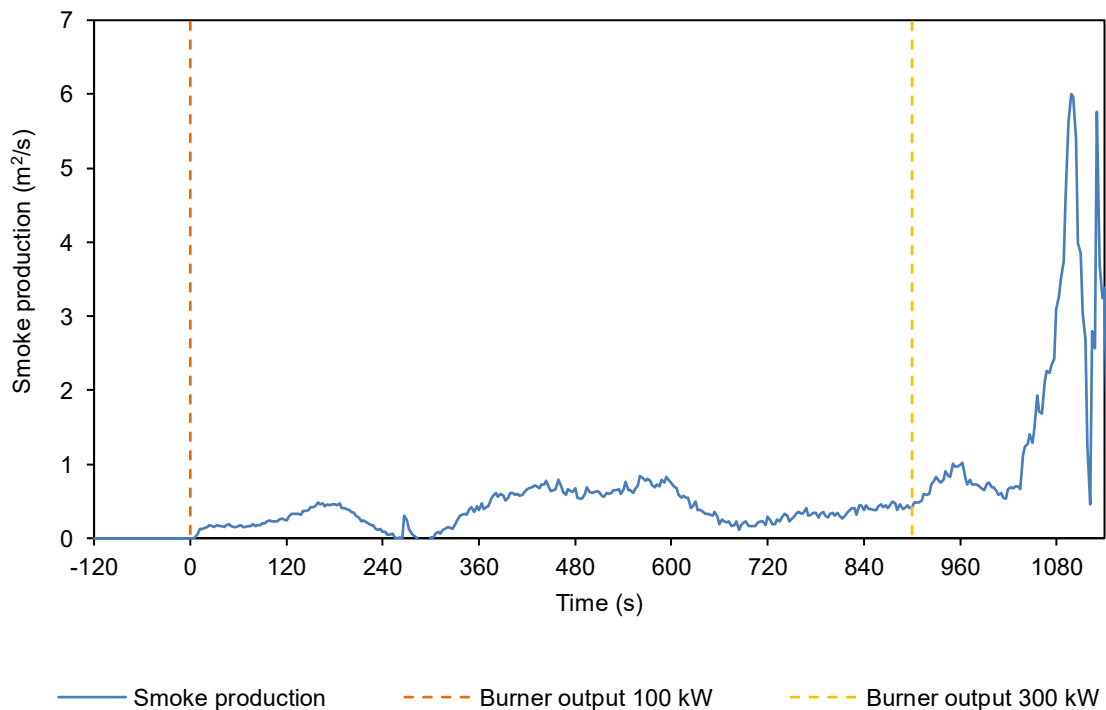
**Figure 5 Heat release rate (HRR) of specimen and burner vs time**



**Figure 6 Production of carbon monoxide vs time, at reference temperature and pressure**



**Figure 7 Production of carbon dioxide vs time, at reference temperature and pressure**



**Figure 8 Production of light obscuring smoke vs time, at reference temperature and pressure**

## **5. Application of test results**

### **5.1 Test limitations**

The results of these fire tests may be used to directly assess fire hazard, but it should be recognised that a single test method will not provide a full assessment of fire hazard under all fire conditions.

These results only relate to the behaviour of the specimen of the element of construction under the particular conditions of the test. They are not intended to be the sole criteria for assessing the potential fire performance of the element in use, and they do not necessarily reflect the actual behaviour in fires.

### **5.2 Variations from the tested specimen**

This report details methods of construction, the test conditions and the results obtained when the specific element of construction described here was tested following the procedure outlined in Table 3. Any significant variation with respect to size, construction details, loads, stresses, edge or end conditions is not addressed by this report.

It is recommended that any proposed variation to the tested configuration should be referred to the test sponsor. They should then obtain appropriate documentary evidence of compliance from Warringtonfire or another accredited testing authority.

### **5.3 Uncertainty of measurements**

Because of the nature of reaction to fire testing and the consequent difficulty in quantifying the uncertainty of measurements obtained from a reaction to fire test, it is not possible to provide a stated degree of accuracy of result.

## Appendix A Test observations

Table 5 shows the observations of any significant behaviour of the specimen during the test.

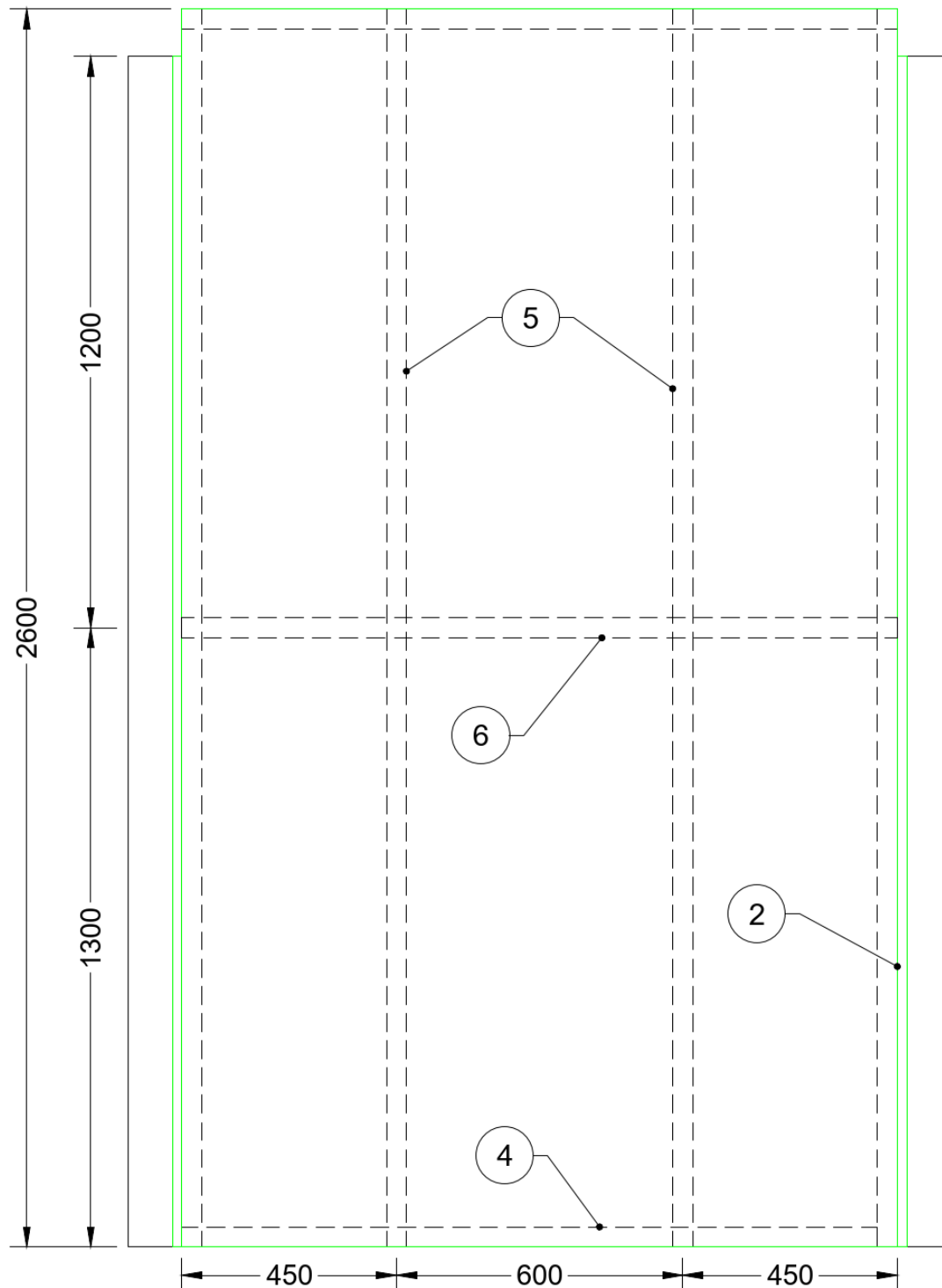
Video recordings were also taken of the test from directly in front of the specimen and from an angle beside the specimen. A copy of the video recording is available upon request by contacting Cladding Safety Victoria. The video of the test should be viewed in conjunction with the contents of this report.

**Table 5 Test observations**

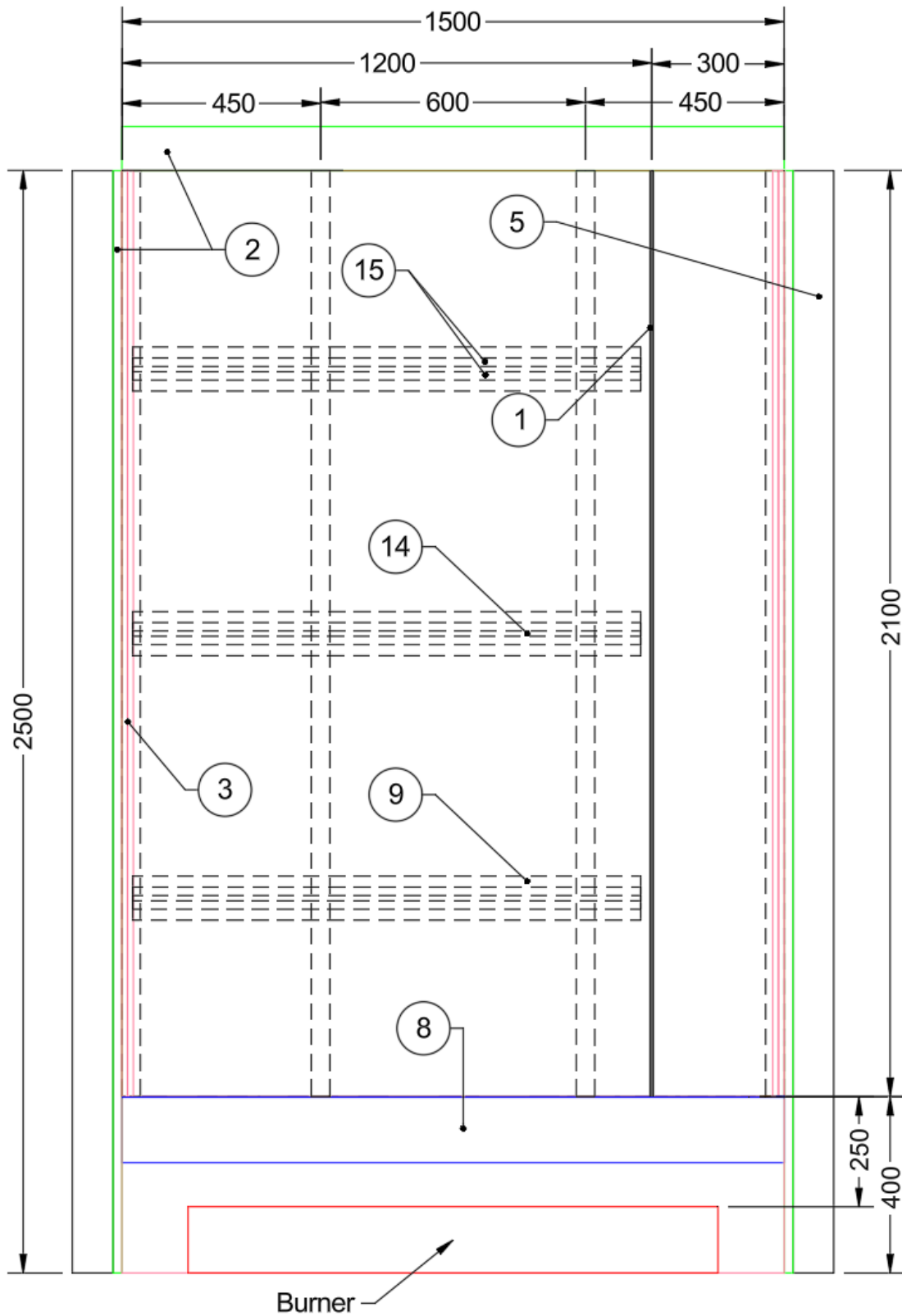
Time		Observation
Min	Sec	
-2	00	Data collection started.
0	00	The reaction to fire test was started with the burner ignited with a heat output set at 100 kW.
0	29	Smoke was emitting from the specimen. Discolouration started at the bottom section of the panels.
2	37	The bottom section of the panels started to deform.
3	15	A crack was observed at the bottom section of east side of the panel.
4	07	Flaming debris fell from the specimen.
6	11	Flaming on the bottom of the west side wall.
7	22	Smoke was emitting from the west corner of the back wall.
13	20	The panel joint started to open.
15	00	The heat output of the burner was increased to 300 kW.
16	19	Flaming on the west corner of the back wall.
17	05	Flaming on the east corner of the back wall.
17	24	The panel joint opened up more.
18	30	A heat release rate of 2.5MW was recorded.
19	00	The reaction to fire test was ended and the specimen was sprayed with water by the test operators. The test was stopped due to safety concerns.

## Appendix B Drawings of test assembly

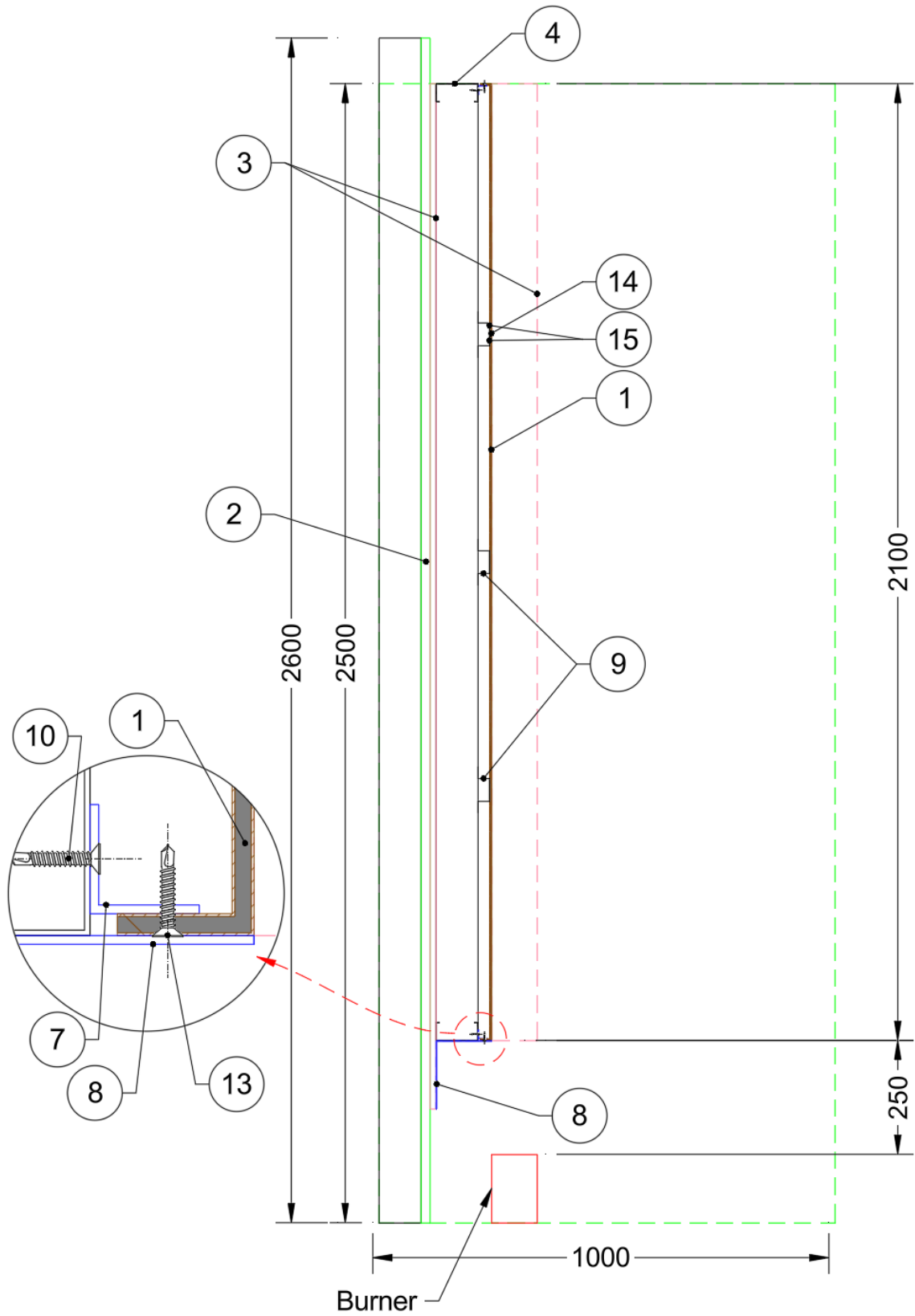
The drawings of the test assembly in Figure 9 to Figure 12 were prepared by representatives of Warringtonfire. The leaders in the drawings represent the items listed in section 2.1. All measurements, unless specified, are in mm.



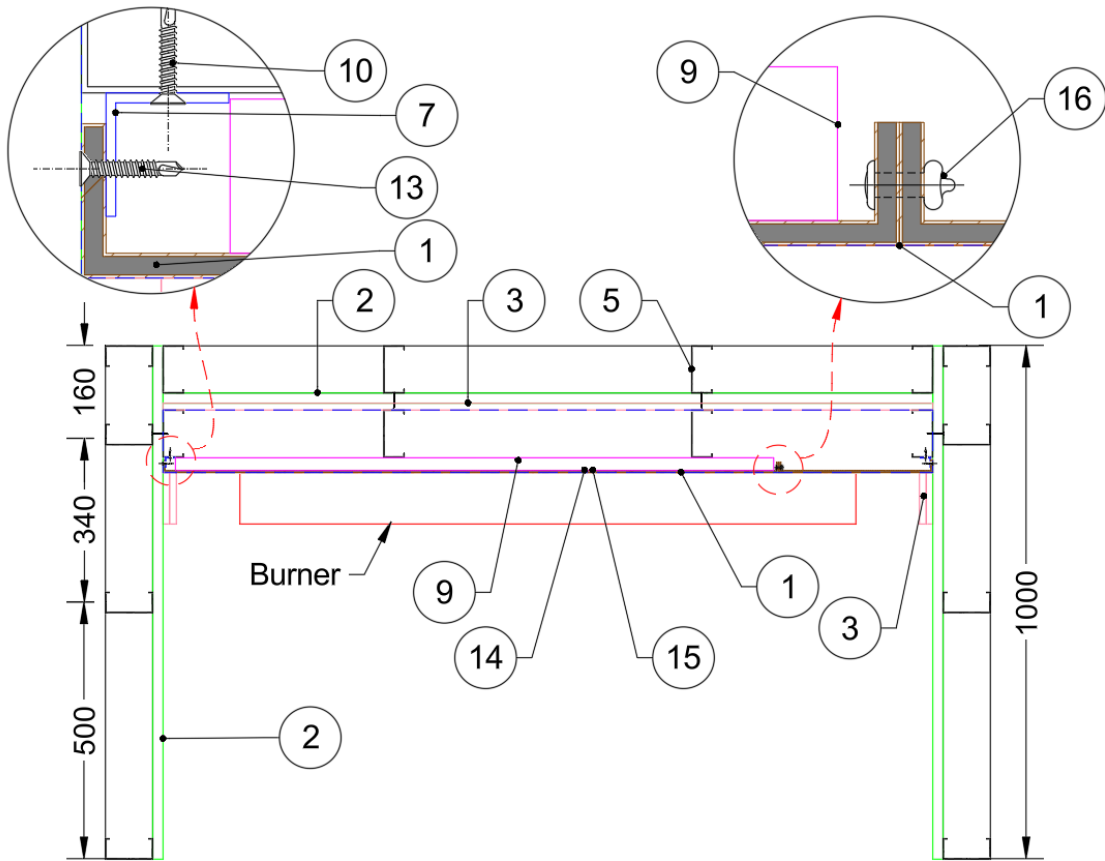
**Figure 9 Elevation of rig support**



**Figure 10 System assembly – Exposed side elevation**

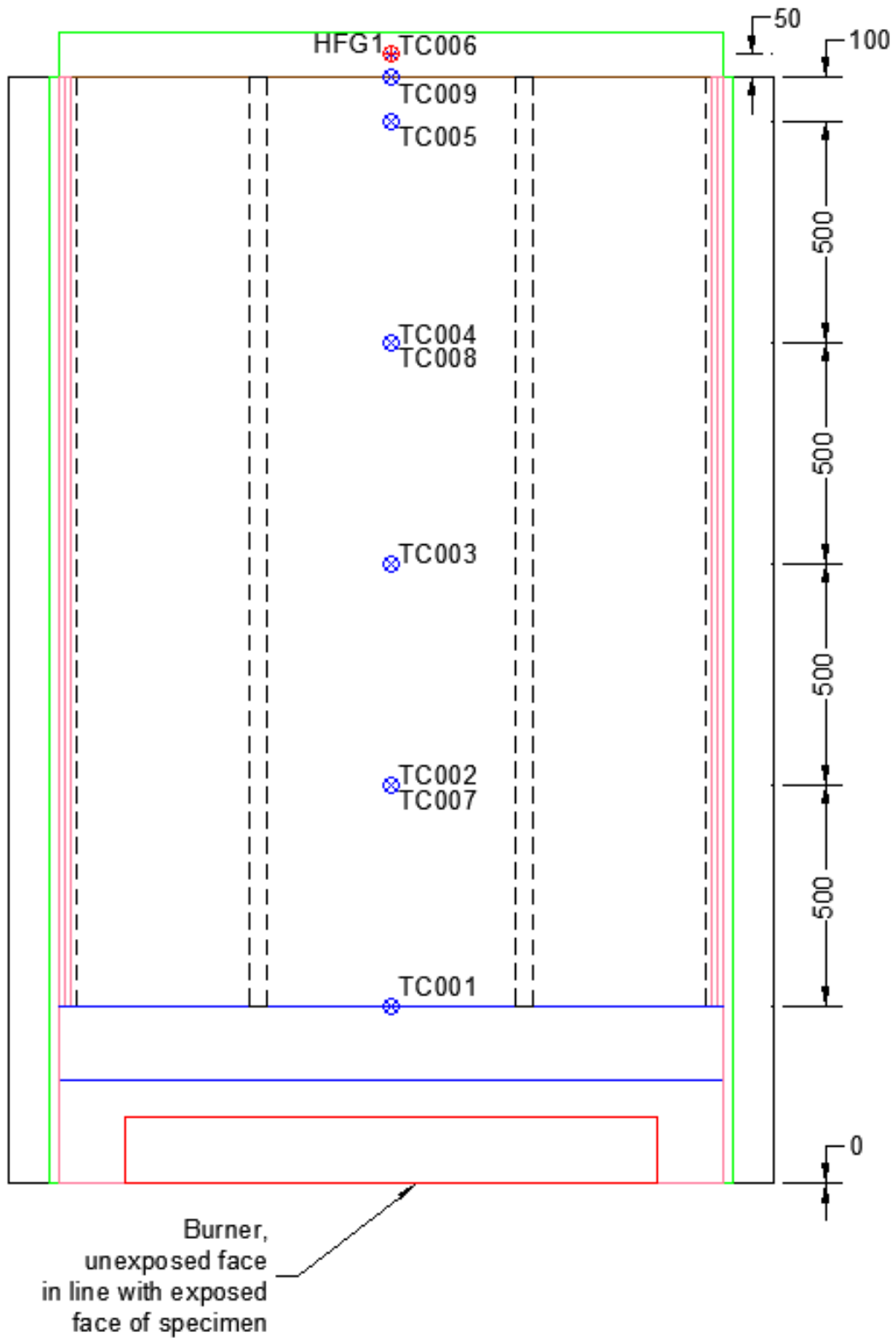


**Figure 11 System assembly – Vertical cross-section A-A**

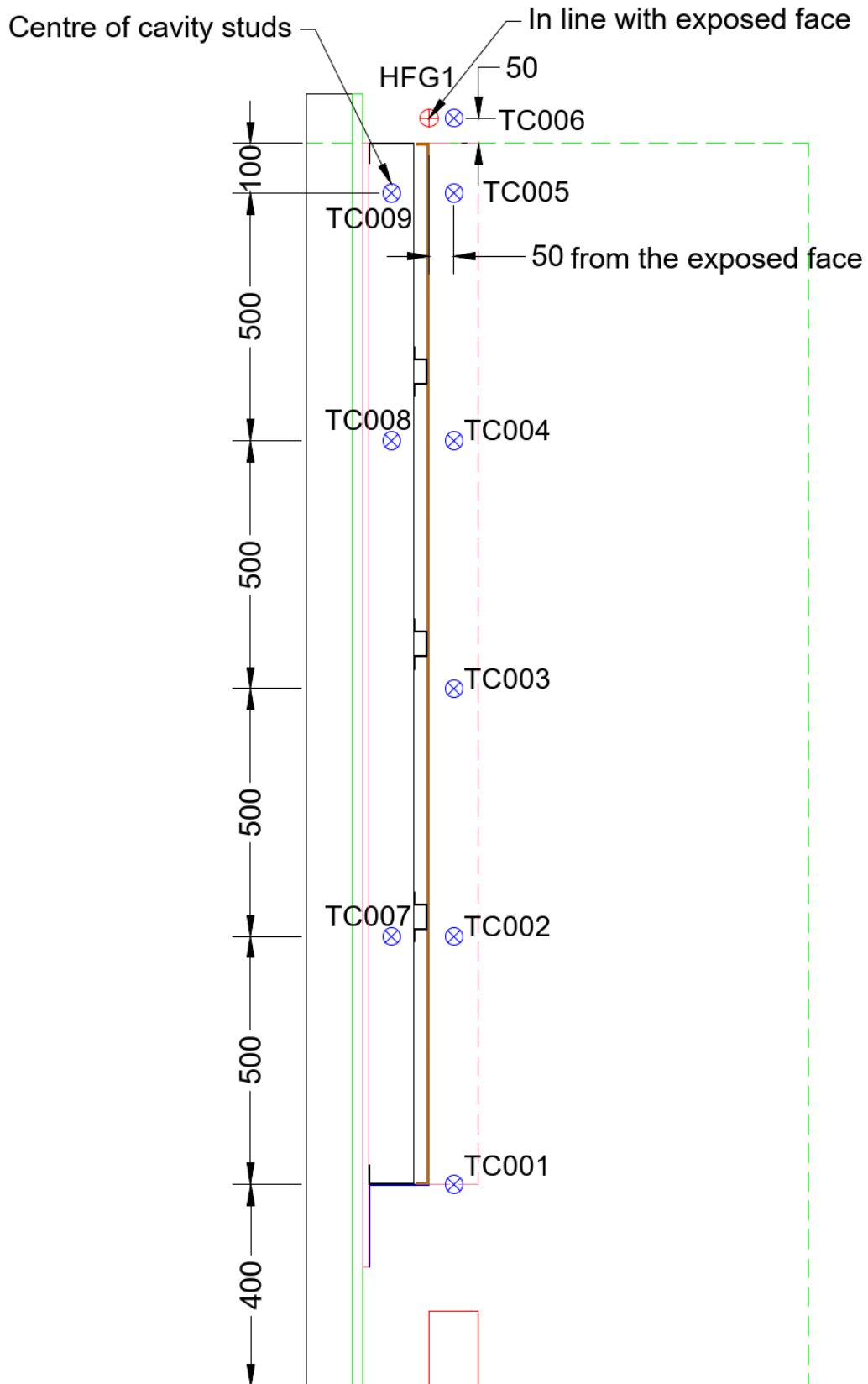


**Figure 12 System assembly – Horizontal cross-section B-B**

## Appendix C Instrumentation locations



**Figure 13 Instrumentation locations – Exposed side view**



**Figure 14 Instrumentation locations – Vertical cross-sectional view**

## Appendix D Photographs



**Figure 15** The specimen before the reaction to fire test – exposed side



**Figure 16 The specimen before the reaction to fire test – unexposed side**



**Figure 17 The specimen 2 minutes into the test (burner output at 100 kW)**



**Figure 18** The specimen 7 minutes into the test (burner output at 100 kW)



**Figure 19 The specimen 14 minutes 59 seconds into the test (burner output at 100 kW)**



**Figure 20 The specimen 15 minutes 02 seconds into the test (burner output at 300 kW)**



**Figure 21 The specimen 17 minutes into the test (burner output at 300 kW)**



**Figure 22 The specimen 18 minutes 54 seconds into the test (burner output at 300 kW)**



**Figure 23** The specimen at end of the reaction to fire test – exposed side



**Figure 24** The specimen after the reaction to fire test – unexposed side

## Appendix E Chemical analysis results



UNSW RESEARCH INFRASTRUCTURE

### Chemical Consulting Laboratory

Mark Wainwright Analytical Centre  
UNSW Sydney NSW 2052 Australia

T: +61(2) 9348 1400 | E: [ccl@unsw.edu.au](mailto:ccl@unsw.edu.au)  
W: [www.analytical.unsw.edu.au/contact-us/commercial-consulting](http://www.analytical.unsw.edu.au/contact-us/commercial-consulting)  
ABN 57 195 873 179 | CRICOS Provider Code 00098G

## Test Report

Prepared by:

### ANALYSIS OF CLADDING SAMPLES

For

**Company:** Warrington Fire  
**Contact:** [REDACTED]  
**Date:** 22 February 2024

**Project No:** 24021

**Prepared by:** [REDACTED]  
**Approved by:** [REDACTED]

**COMMERCIAL-IN-CONFIDENCE**

*Any use of the Test Report, use of any part of it, use of the names University of New South Wales or UNSW, use of the name of any Unit of UNSW, or use of the name of the consultant in direct or indirect advertising or publicity is strictly forbidden.*



## Analysis of Cladding Samples

### 1. SAMPLES

One envelope containing three ACP cores was received for analysis. The samples were identified as follows:

CCL sample coding	Client sample coding
24021-1	#1 - 100%
24021-2	#2 - 100%

CCL has been asked to identify the polymer and the filler (s) in the samples by FT/IR, quantitate and identify the mineral filler in the samples and classify them in accordance with the ICA cladding scheme.

### 2. METHODOLOGY AND RESULTS

The aluminium metals were removed from the ACPs cladding polymer, and the flat surface of the polymer sample was abraded to remove any surface adhesive. The surface of the sample was analysed directly by FTIR. The FT-IR spectra are presented in Figures 1-3.

The core of the samples was then ashed to determine their percentage mineral content (Table 1). If sufficient (>0.5 g) ash was found in the sample, it was analysed for elemental composition by X ray fluorescence spectroscopy. Results are presented in Table 2.

Table 1 Ash content of 24021-1-3

Sample coding	Ash content (w/w%)
24021-1	3.3
24021-2	3.0


### 3. CONCLUSIONS

The cladding sample #1 consisted of 3.3% inert material and approximately 96% polyethylene polymer.  
**The cladding sample #1 is classified as ICA category A.**

The cladding sample #2 consisted of 3.0% inert material and approximately 97% polyethylene polymer.  
**The cladding sample #2 is classified as ICA category A.**

**The ICA Classification assigned is correct as per the September 2020 revision of the ICA Guidelines.**

*The reader is reminded that we can only analyse and classify the content of samples actually presented to us. We can offer no guarantee that this composition or classification is valid for cladding as a whole, because some types of cladding can be inhomogeneous, and a sample may not be representative of the cladding as a whole. Anyone using our results should consider these sampling issues and uncertainties before they generalise the results we present to anybody of cladding as a whole.*

  
Senior Technical Officer  
Chemical Consulting Laboratory  
Mark Wainwright Analytical Centre, UNSW  
22 February 2024



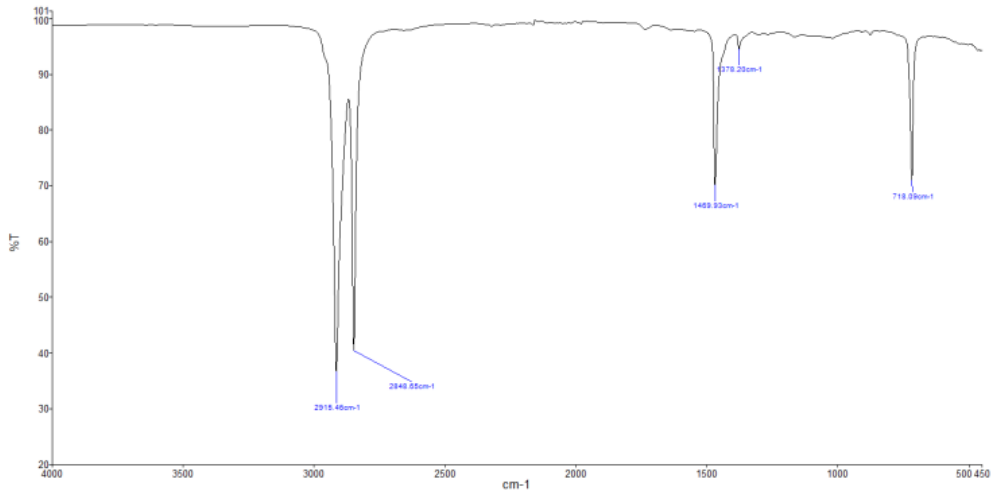


Figure 1. FT-IR spectrum of sample #1

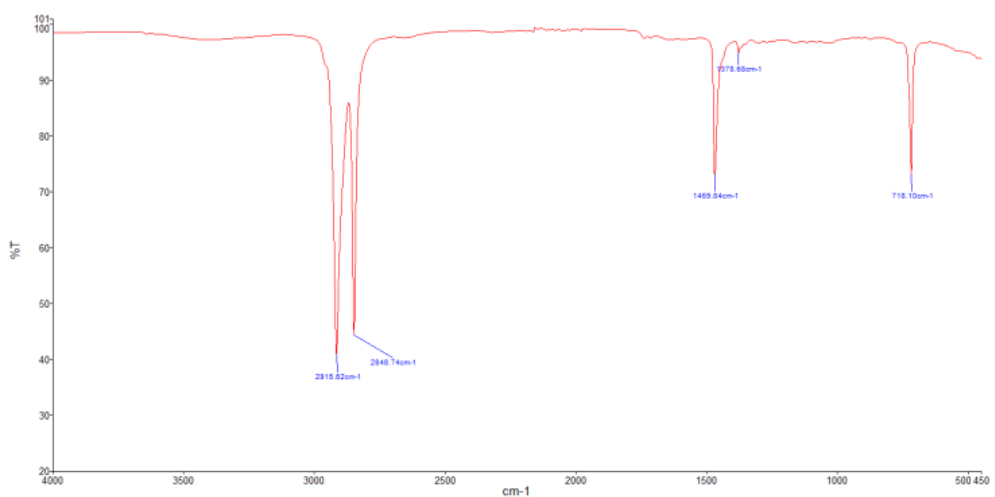


Figure 2. FT-IR spectrum of sample #2





# WARRINGTONFIRE AUSTRALIA

A Jensen Hughes Company

Warringtonfire Australia Pty Ltd  
ABN 81 050 241 524

#### Perth

Suite 4.01, 256 Adelaide Terrace  
Perth WA 6000  
Australia  
T: +61 8 9382 3844

#### Canberra

Unit 10, 71 Leichhardt Street  
Kingston ACT 2604  
Australia  
T: +61 2 6260 8488

#### Melbourne

Level 4, 152 Elizabeth Street  
Melbourne Vic 3000  
Australia  
T: +61 3 9767 1000

#### Sydney

Suite 802, Level 8, 383 Kent Street  
Sydney NSW 2000  
Australia  
T: +61 2 9211 4333

#### Brisbane

Suite B, Level 6, 133 Mary Street  
Brisbane Qld 4000  
Australia  
T: +61 7 3238 1700

#### Melbourne – NATA accredited laboratory

409-411 Hammond Road  
Dandenong South Vic 3175  
Australia  
T: +61 3 9767 1000

#### General conditions of use

The data, methodologies, calculations and results documented in this report specifically relate to the tested specimen/s and must not be used for any other purpose. This report may only be reproduced in full. Extracts or abridgements must not be published without permission from Warringtonfire.

All work and services carried out by Warringtonfire are subject to, and conducted in accordance with our standard terms and conditions. These are available on request.